



TRANSISTORIZED INVERTER

FR-S500

INSTRUCTION MANUAL (BASIC)

FR-S520E-0.1K to 3.7K(-C)

FR-S540E-0.4K to 3.7K

FR-S520SE-0.1K to 1.5K

FR-S510WE-0.1K to 0.75K

Thank you for choosing this Mitsubishi transistorized inverter.

If this is the first time for you to use the FR-S500 series, please read through this instruction manual (basic) carefully and use the inverter safely.

If you are going to use the inverter for higher-level applications, the FR-S500 instruction manual (detailed) [IB(NA)-0600152E] is separately available from where you purchased the inverter or a Mitsubishi sales representative.

CONTENTS

1	CONNECTION OF PERIPHERAL DEVICES (BASIC CONFIGURATION)	3
2	INSTALLATION METHOD.....	6
	2.1 Installation of the inverter.....	6
3	SPECIFICATIONS OF WIRING AND TERMINALS	7
	3.1 Terminal connection diagram	7
	3.2 Main circuit.....	8
	3.3 Control circuit.....	12
	3.4 Failsafe of the system which uses the inverter.....	19
4	DRIVE THE MOTOR.....	21
	4.1 Step of operation	21
	4.2 Run and operation.....	22
	4.3 Operation by the start command from the operation panel (PU operation mode).....	24
	4.4 Operation by the start command of the terminal block (external operation).....	31
	4.5 Clearing the parameters.....	39
	4.6 Monitoring the output current.....	40
5	ADJUSTMENT OF THE FREQUENCY SETTING	
	POTENTIOMETER AND INDICATOR.....	41
	5.1 Changing the output frequency setting of the frequency setting potentiometer (bias and gain of frequency setting voltage (current))	42
	5.2 Adjustment (calibration) of the frequency meter (indicator).....	46
6	FUNCTION LIST	47
	6.1 Basic function parameter list.....	47
	6.2 Explanation of the basic function parameters	48
	6.3 Setting the parameters	50
	6.4 Display the extended function parameter	51
	6.5 Extended function parameter list	52
7	ERRORS AND PROTECTIVE FUNCTIONS	66
	7.1 About errors (definitions).....	66
	7.2 Checking of the alarm history	69
	7.3 To know the operating status at the occurrence of alarm (only when FR-PU04 is used).....	70
	7.4 Correspondence between digital and actual characters.....	70
	7.5 Resetting the inverter.....	70
	7.6 Troubleshooting	71
	7.7 Precautions for maintenance and inspection.....	74
8	SPECIFICATIONS	80
	8.1 Ratings.....	80
	8.2 Common specifications.....	84
9	OUTLINE DIMENSION DRAWINGS	86
	Appendix 1 Instructions for compliance with the European Directive	89
	Appendix 2 Instructions for UL and cUL.....	91

1

2

3

4

5

6

7

8

9

This instruction manual (basic) provides handling information and precautions for use of the equipment.

Please forward this instruction manual (basic) to the end user.

This section is specifically about safety matters

Do not attempt to install, operate, maintain or inspect the inverter until you have read through this instruction manual (basic) and appended documents carefully and can use the equipment correctly. Do not use the inverter until you have a full knowledge of the equipment, safety information and instructions.

In this instruction manual (basic), the safety instruction levels are classified into "WARNING" and "CAUTION".



WARNING

Assumes that incorrect handling may cause hazardous conditions, resulting in death or severe injury.



CAUTION

Assumes that incorrect handling may cause hazardous conditions, resulting in medium or slight injury, or may cause physical damage only.

Note that even the  **CAUTION** level may lead to a serious consequence according to conditions. Please follow the instructions of both levels because they are important to personnel safety.

1. Electric Shock Prevention



WARNING

- While power is on or when the inverter is running, do not open the front cover. You may get an electric shock.
- Do not run the inverter with the front cover or wiring cover removed. Otherwise, you may access the exposed high-voltage terminals or the charging part of the circuitry and get an electric shock. Also, the inverter's ability to withstand earthquakes will deteriorate.
- Even if power is off, do not remove the front cover except for wiring or periodic inspection. You may access the charged inverter circuits and get an electric shock.
- Before starting wiring or inspection, check to make sure that the 3-digit LED inverter monitor is off, wait for at least 10 minutes after the power supply has been switched off, and check to make sure that there are no residual voltage using a tester or the like.
- This inverter must be earthed (grounded). Earthing (grounding) must conform to the requirements of national and local safety regulations and electrical codes. (NEC section 250, IEC 536 class 1 and other applicable standards)
- Any person who is involved in the wiring or inspection of this equipment should be fully competent to do the work.
- Always install the inverter before wiring. Otherwise, you may get an electric shock or be injured.
- Perform setting dial and key operations with dry hands to prevent an electric shock.
- Do not subject the cables to scratches, excessive stress, heavy loads or pinching. Otherwise, you may get an electric shock.
- Do not change the cooling fan while power is on. It is dangerous to change the cooling fan while power is on.
- When you have removed the front cover, do not touch the connector above the 3-digit monitor LED display. Otherwise, you get an electric shock.

2. Fire Prevention

CAUTION

- Install the inverter and brake resistor on an incombustible wall without holes, etc. Installing the inverter and brake resistor directly on or near a combustible surface could lead to a fire.
- If the inverter has become faulty, switch off the inverter power. A continuous flow of large current could cause a fire.
- When using a brake resistor, make up a sequence that will turn off power when an alarm signal is output. Otherwise, the brake resistor may excessively overheat due to damage of the brake transistor and such, causing a fire.
- Do not connect the resistor directly to the DC terminals P and N. This could cause a fire.

3. Injury Prevention

CAUTION

- Apply only the voltage specified in the instruction manual to each terminal to prevent damage, etc.
- Always connect to the correct terminal to prevent damage, etc.
- Always make sure that polarity is correct to prevent damage, etc.
- While power is on or for some time after power-off, do not touch the inverter as it is hot and you may get burnt.

4. Additional Instructions

Also note the following points to prevent an accidental failure, injury, electric shock, etc.

(1) Transportation and installation

CAUTION

- When carrying products, use correct lifting gear to prevent injury.
- Do not stack the inverter boxes higher than the number recommended.
- Ensure that installation position and material can withstand the weight of the inverter. Install according to the information in the instruction manual.
- Do not install or operate if the inverter is damaged or has parts missing.
- When carrying the inverter, do not hold it by the front cover or setting dial; it may fall off or fail.
- Do not stand or rest heavy objects on the inverter.
- Check the inverter mounting orientation is correct.
- Prevent other conductive bodies as screws and metal fragments or other flammable substance as oil from entering the inverter.
- As the inverter is a precision instrument, do not drop or subject it to impact.
- Use the inverter under the following environmental conditions: This could cause the inverter damage.

Environment	Ambient Temperature	-10°C to +50°C (non-freezing) (-10°C to +40°C for totally enclosed structure feature)
	Ambient humidity	90%RH maximum (non-condensing)
	Storage temperature	-20°C to +65°C *
	Atmosphere	Indoors (free from corrosive gas, flammable gas, oil mist, dust and dirt)
	Altitude/vibration	Max.1000m above sea level 5.9m/s ² or less

*Temperatures applicable for a short time, e.g. in transit.

(2) Wiring

CAUTION

- Do not fit capacitive equipment such as power factor correction capacitor, capacitor type filter (option FR-BIF(-H)) or surge suppressor to the output of the inverter.
- The connection orientation of the output cables U, V, W to the motor will affect the direction of rotation of the motor.

(3) Trial run

CAUTION

- Check all parameters, and ensure that the machine will not be damaged by a sudden start-up.
- When the load GD^2 is small (at the motor GD or smaller) for 400V from 1.5K to 3.7K, the output current may vary when the output frequency is in the 20Hz to 30Hz range. If this is a problem, set the Pr.72 "PWM frequency selection" to 6kHz or higher. (When setting the PWM to a higher frequency, check for noise or leakage current problem and take countermeasures against it.)

(4) Operation

WARNING

- When you have chosen the retry function, stay away from the equipment as it will restart suddenly after an alarm stop.
- Since the [STOP] key is valid only when functions are set (refer to page 59), provide a circuit and switch separately to make an emergency stop (power off, mechanical brake operation for emergency stop, etc).
- Make sure that the start signal is off before resetting the inverter alarm. A failure to do so may restart the motor suddenly.
- The load used should be a three-phase induction motor only. Connection of any other electrical equipment to the inverter output may damage the equipment.
- Do not modify the equipment.
- Do not perform parts removal which is not instructed in this manual. Doing so may lead to fault or damage of the inverter.

CAUTION

- The electronic thermal relay function does not guarantee protection of the motor from overheating.
- Do not use a magnetic contactor on the inverter input for frequent starting/stopping of the inverter.
- Use a noise filter to reduce the effect of electromagnetic interference. Otherwise nearby electronic equipment may be affected.
- Take measures to suppress harmonics. Otherwise power supply harmonics from the inverter may heat/damage the power capacitor and generator.
- When a 400V class motor is inverter-driven, please use an insulation-enhanced motor or measures taken to suppress surge voltages. Surge voltages attributable to the wiring constants may occur at the motor terminals, deteriorating the insulation of the motor.
- When parameter clear or all clear is performed, reset the required parameters before starting operations. Each parameter returns to the factory setting.
- The inverter can be easily set for high-speed operation. Before changing its setting, fully examine the performances of the motor and machine.
- In addition to the inverter's holding function, install a holding device to ensure safety.
- Before running an inverter which had been stored for a long period, always perform inspection and test operation.

(5) Emergency stop

CAUTION

- Provide a safety backup such as an emergency brake which will prevent the machine and equipment from hazardous conditions if the inverter fails.
- When the breaker on the inverter primary side trips, check for the wiring fault (short circuit), damage to internal parts of the inverter, etc. Identify the cause of the trip, then remove the cause and power on the breaker.
- When any protective function is activated, take the appropriate corrective action, then reset the inverter, and resume operation.

(6) Maintenance, inspection and parts replacement

CAUTION

- Do not carry out a megger (insulation resistance) test on the control circuit of the inverter.

(7) Disposing of the inverter

CAUTION

- Treat as industrial waste.

(8) General instructions

Many of the diagrams and drawings in this instruction manual (basic) show the inverter without a cover, or partially open. Never operate the inverter in this manner. Always replace the cover and follow this instruction manual (basic) when operating the inverter.

Harmonic Suppression Guideline

All models of general-purpose inverters used by specific consumers are covered by "Harmonic suppression guideline for consumers who receive high voltage or special high voltage". (For further details, refer to Instruction Manual (detailed).)

Product Checking and Parts Identification

Unpack the inverter and check the capacity plate on the front cover and the rating plate on the inverter side face to ensure that the product agrees with your order and the inverter is intact.

- Parts and name plate

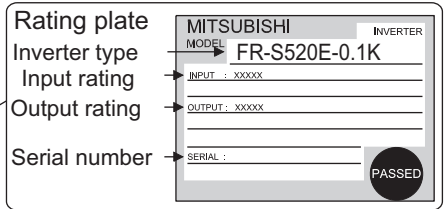
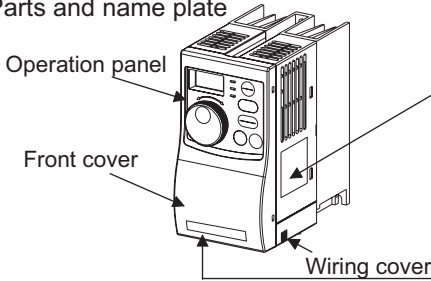

- Inverter type

FR - **S520E** - **0.1** K -

Symbol	Voltage class
S520E	Three-phase 200V class
S540E	Three-phase 400V class
S520SE	Single-phase 200V class
S510WE	Single-phase 100V class

Inverter capacity "kW"

Symbol	Structure, terminal symbol, etc.
None	Enclosed type
C	Totally enclosed structure IP40

● **Removal and reinstallation of the front cover**

Remove the front cover by pulling it toward you in the direction of arrow.
To reinstall, match the cover to the inverter front and install it straight.



FR-S520E-0.1K to 0.75K
FR-S520SE-0.1K to 0.75K
FR-S510WE-0.1K to 0.4K

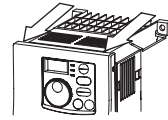

FR-S520E-1.5K to 3.7K
FR-S520SE-1.5K
FR-S540E-0.4K to 3.7K
FR-S510WE-0.75K

● **Removal and reinstallation of the wiring cover**

The cover can be removed easily by pulling it toward you.

To reinstall, fit the cover to the inverter along the guides.

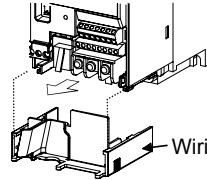

● **RS-485 communication connector**

When using the RS-485 connector to wire the cable, you can cut off the tab of the wiring cover to wire it. (Cutting off the tab will provide protective structure IP10.)

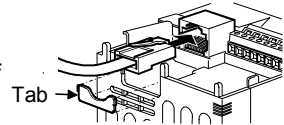

CAUTION

The connector above the operation panel is for manufacturer use. Do not touch it as doing so may cause an electric shock.

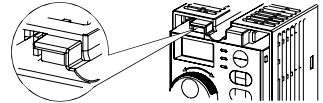

1. CONNECTION OF PERIPHERAL DEVICES (BASIC CONFIGURATION)

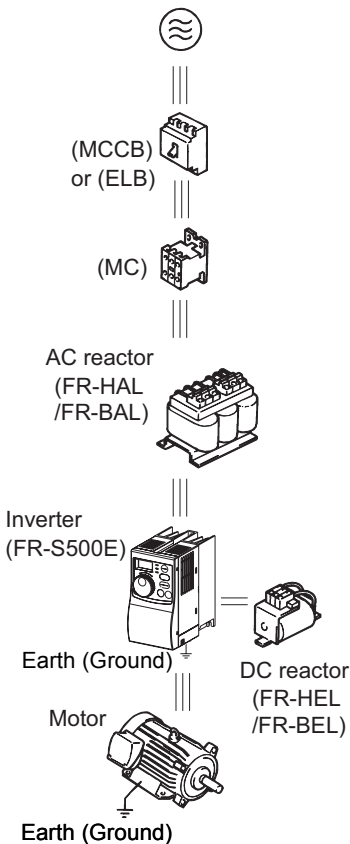

Power supply

Use within the permissible power supply specifications of the inverter. (Refer to page 80.)

Moulded case circuit breaker or earth leakage circuit breaker

The breaker must be selected carefully since an in-rush current flows in the inverter at power on.

Magnetic contactor

Install for your safety. Do not use this magnetic contactor to start and stop the inverter. Doing so will cause the inverter life to be shorten. (Refer to page 18.)

Installation of a reactor

A reactor must be used when the power harmonics measure is taken, power factor is to be improved or the inverter is installed near a large supply system (500kVA or more and wiring distance within 10 m). Make the selection carefully.

Inverter

The life of the inverter is influenced by ambient temperature. Check the ambient temperature. Especially when mounting the inverter inside an enclosure, take cautions of the ambient temperature. (Refer to page 85.)

Wrong wiring might lead to damage of the inverter. The control signal wires must be kept fully away from the main circuit to protect them from noise. (Refer to page 7.)

Devices connected to the output

Do not install a power factor correction capacitor, surge suppressor or capacitor type filter on the output side of the inverter.

When installing a moulded case circuit breaker on the output side of the inverter, contact each manufacturer for selection of the moulded case circuit breaker.

Earth (Ground)

To prevent an electric shock, always earth (ground) the motor and inverter.

For reduction of induction noise from the power line of the inverter, it is recommended to wire the earth (ground) cable by returning it to the earth (ground) terminal of the inverter.

(For details of noise reduction techniques, refer to the instruction manual (detailed).)

1

CONNECTION OF PERIPHERAL DEVICES (BASIC CONFIGURATION)

Selection of peripheral devices (selection changes with the power input specifications of the inverter)

1) Three-phase 200V power input

Motor Output (kW)	Applied Inverter Type	Moulded Case Circuit Breaker (MCCB *1, 4) or Earth Leakage Circuit Breaker (ELB) (*2, 4)	Magnetic Contactor (MC) (Refer to page 18)	AC Reactor FR-HAL-□□K FR-BAL-□□K	DC Reactor FR-HEL-□□K FR-BEL-□□K
0.1	FR-S520E-0.1K(-C)	30AF/5A	S-N10	0.4 (*3)	0.4 (*3)
0.2	FR-S520E-0.2K(-C)	30AF/5A	S-N10	0.4 (*3)	0.4 (*3)
0.4	FR-S520E-0.4K(-C)	30AF/5A	S-N10	0.4	0.4
0.75	FR-S520E-0.75K(-C)	30AF/10A	S-N10	0.75	0.75
1.5	FR-S520E-1.5K(-C)	30AF/15A	S-N10	1.5	1.5
2.2	FR-S520E-2.2K(-C)	30AF/20A	S-N10	2.2	2.2
3.7	FR-S520E-3.7K(-C)	30AF/30A	S-N20, S-N21	3.7	3.7

2) Three-phase 400V power input

Motor Output (kW)	Applied Inverter Type	Moulded Case Circuit Breaker (MCCB *1, 4) or Earth Leakage Circuit Breaker (ELB) (*2, 4)	Magnetic Contactor (MC) (Refer to page 18)	AC Reactor FR-HAL-□□K FR-BAL-□□K	DC Reactor FR-HEL-□□K FR-BEL-□□K
0.4	FR-S540E-0.4K	30AF/5A	S-N10	H0.4	H0.4
0.75	FR-S540E-0.75K	30AF/5A	S-N10	H0.75	H0.75
1.5	FR-S540E-1.5K	30AF/10A	S-N10	H1.5	H1.5
2.2	FR-S540E-2.2K	30AF/15A	S-N10	H2.2	H2.2
3.7	FR-S540E-3.7K	30AF/20A	S-N20, S-N21	H3.7	H3.7

3) Single-phase 200V power input

Motor Output (kW)	Applied Inverter Type	Moulded Case Circuit Breaker (MCCB *1, 4) or Earth Leakage Circuit Breaker (ELB) (*2, 4)	Magnetic Contactor (MC) (Refer to page 18)	AC Reactor (*3) FR-HAL-□□K FR-BAL-□□K	DC Reactor (*3) FR-HEL-□□K FR-BEL-□□K
0.1	FR-S520SE-0.1K	30AF/5A	S-N10	0.4	0.4
0.2	FR-S520SE-0.2K	30AF/10A	S-N10	0.4	0.4
0.4	FR-S520SE-0.4K	30AF/10A	S-N20, S-N21	0.75	0.75
0.75	FR-S520SE-0.75K	30AF/15A	S-N20, S-N21	1.5	1.5
1.5	FR-S520SE-1.5K	30AF/20A	S-N20, S-N21	2.2	2.2

4) Single-phase 100V power input

Motor Output (kW)	Applied Inverter Type	Moulded Case Circuit Breaker (MCCB *1, 4) or Earth Leakage Circuit Breaker (ELB) (*2, 4)	Magnetic Contactor (MC) (Refer to page 18)	AC Reactor (*3) FR-HAL-□□K FR-BAL-□□K	DC Reactor (*5) FR-HEL-□□K FR-BEL-□□K
0.1	FR-S510WE-0.1K	30AF/10A	S-N10	0.75	—
0.2	FR-S510WE-0.2K	30AF/15A	S-N10	1.5	—
0.4	FR-S510WE-0.4K	30AF/20A	S-N20, S-N21	2.2	—
0.75	FR-S510WE-0.75K	30AF/30A	S-N20, S-N21	3.7	—

- *1. • Select the MCCB according to the power supply capacity.
• Install one MCCB per inverter.

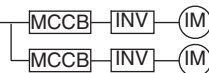

- *2. For installations in the United States or Canada, the circuit breaker must be inverse time or instantaneous trip type.
*3. The power factor may be slightly lower.
*4. When the breaker on the inverter primary side trips, check for the wiring fault (short circuit), damage to internal parts of the inverter, etc. Identify the cause of the trip, then remove the cause and power on the breaker.
*5. The single-phase 100V power input model is not compatible with the DC reactor.

2. INSTALLATION METHOD



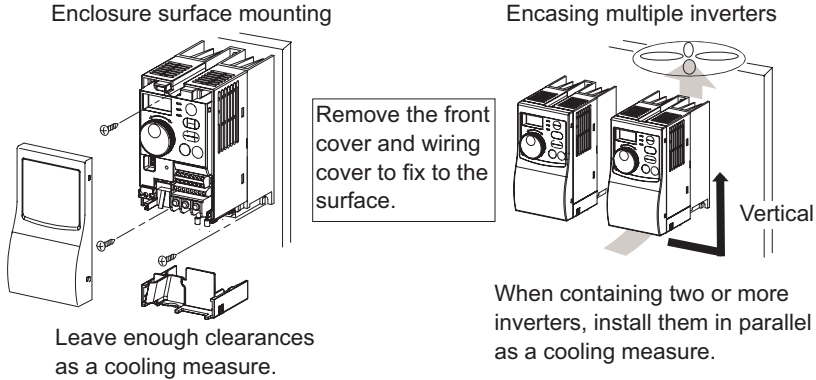

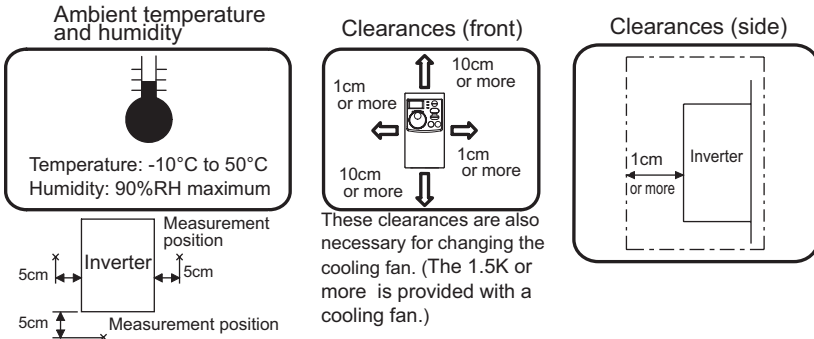

2.1 Installation of the inverter

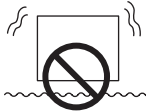

- Install the inverter under the following conditions.

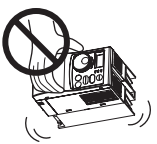

- Inverter consists of precision mechanical and electronic parts. Never install or handle it in any of the following conditions as doing so could cause an operation fault or failure.

			
Direct sunlight	Vibration (5.9m/s^2 or more)	High temperature, high humidity	Horizontal placement
			
Vertical mounting (when mounting inside an enclosure)	Transportation by holding front cover or dial	Oil mist, flammable gas, corrosive gas, fluff, dust, etc.	Mounting to combustible material

3. SPECIFICATIONS OF WIRING AND TERMINALS

3.1 Terminal connection diagram

- Three-phase 200V power input
- Three-phase 400V power input

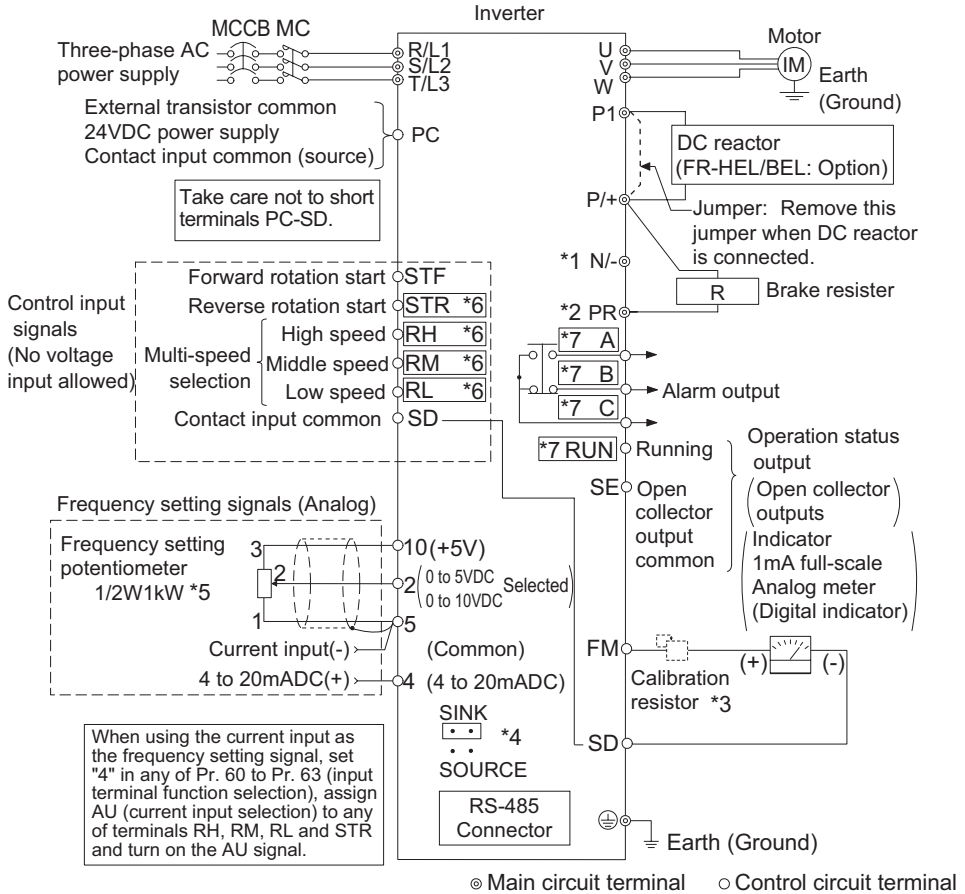

REMARKS

- *1. The N/- terminal is not provided for the FR-S520E-0.1K to 0.75K.
- *2. The PR terminal is provided for the FR-S520E-0.4K to 3.7K.
- *3. Not needed when the setting dial is used for calibration. Used when calibration must be made near the frequency meter for such a reason as a remote frequency meter. However, the frequency meter needle may not deflect to full-scale if the calibration resistor is connected. In this case, use this resistor and setting dial together.
- *4. You can switch the position of sink and source logic. (Refer to page 16.)
- *5. When the setting potentiometer is used frequently, use a 2W1kΩ potentiometer.
- *6. The terminal functions change with input terminal function selection (Pr. 60 to Pr. 63). (Refer to page 57.) (RES, RL, RM, RH, RT, AU, STOP, MRS, OH, REX, JOG, X14, X16, (STR) signal selection)
- *7. The terminal function changes according to the setting of output terminal function selection (Pr. 64, Pr. 65). (Refer to page 57.) (RUN, SU, OL, FU, RY, Y12, Y13, FDN, FUP, RL, Y93, Y95, LF, ABC signal selection)

CAUTION

To prevent a malfunction due to noise, keep the signal cables more than 10cm away from the power cables.

- Single-phase 200V power input
- Single-phase 100V power input



REMARKS

- To ensure safety, connect the power input to the inverter via a magnetic contactor and earth leakage circuit breaker or moulded case circuit breaker, and use the magnetic contactor to switch power on-off.
- The output is three-phase 200V.

3.2 Main circuit

3.2.1 Explanation of main circuit terminals

Terminal Symbol	Terminal Name	Description
R/L1, S/L2, T/L3 (*1)	AC power input	Connect to the commercial power supply.
U, V, W	Inverter output	Connect a three-phase squirrel-cage motor.
P/+, PR (*2)	Brake resistor connection	Connect the optional brake resistor (MRS/MYS type, FR-ABR) (The brake resistor can be connected to the FR-S520E-0.4K to 3.7K only.)
P/+, N/-	Brake unit connection	Connect the brake unit (BU), power regeneration common converter (FR-CV) or high power factor converter (FR-HC). (The N/- terminal is not provided for the FR-S520E-0.1K to 0.75K.)
P/+, P1	DC reactor connection	Remove the jumper across terminals P - P1 and connect the optional DC reactor (FR-HEL(-H)/FR-BEL(-H)). (The single-phase 100V power input model cannot be connected.)
	Earth (ground)	For earthing (grounding) the inverter chassis. Must be earthed (grounded).

*1. When using single-phase power input, terminals are R/L1 and S/L2.

*2. The PR terminal is provided for the FR-S520E-0.4K to 3.7K.

3.2.2 Terminal block layout

1) Three-phase 200V power input

- FR-S520E-0.1K, 0.2K (-C)

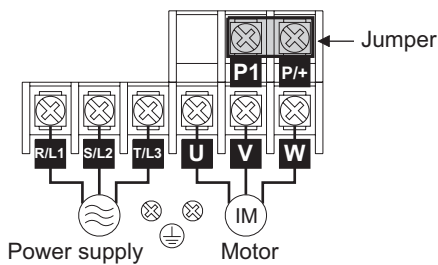

- FR-S520E-1.5K, 2.2K, 3.7K (-C)

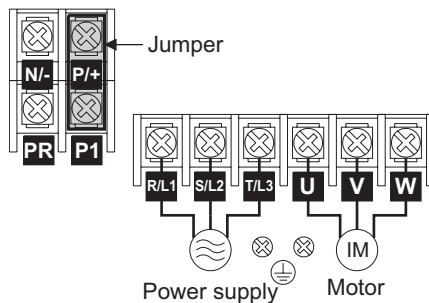

- FR-S520E-0.4K, 0.75K (-C)

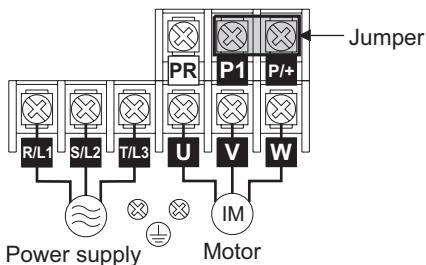

2) Three-phase 400V power input

- FR-S540E-0.4K, 0.75K, 1.5K, 2.2K, 3.7K (-C)

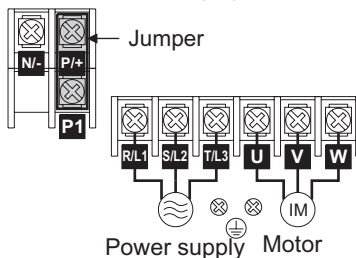

3) Single-phase 200V power input

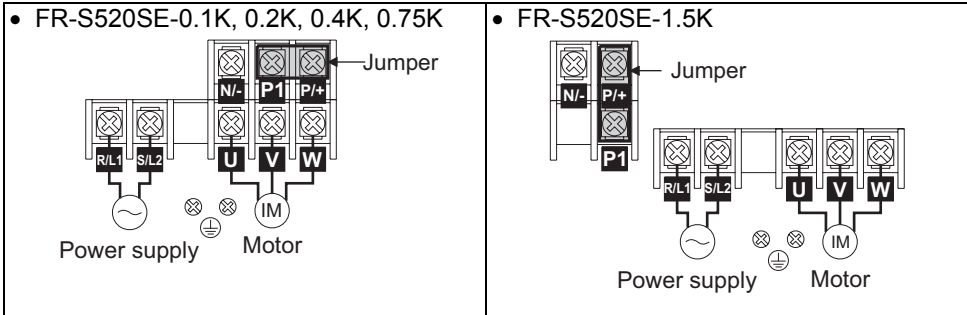

4) Single-phase 100V power input

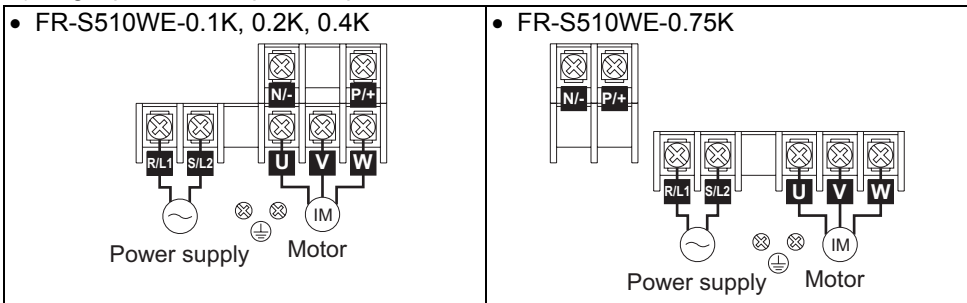

CAUTION

- Make sure the power cables are connected to the R/L1, S/L2, T/L3 of the inverter. Never connect the power cable to the U, V, W of the inverter. Doing so will damage the inverter. (Phase need not be matched)
- Connect the motor to U, V, W. At this time, turning on the forward rotation switch (signal) rotates the motor in the counterclockwise direction when viewed from the motor shaft.

3.2.3 Cables, wiring length, and crimping terminals

The following table indicates a selection example for the wiring length of 20m.

1) Three-phase 200V power input

Applied Inverter	Terminal Screw size	Tightening Torque N·m	Crimping Terminal		Cable Size					
					HIV cable (mm ²)		AWG		PVC cable (mm ²)	
					R, S, T	U, V, W	R, S, T	U, V, W	R, S, T	U, V, W
FR-S520E-0.1K to 0.75K (-C)	M3.5	1.2	2-3.5	2-3.5	2	2	14	14	2.5	2.5
FR-S520E-1.5K, 2.2K (-C)	M4	1.5	2-4	2-4	2	2	14	14	2.5	2.5
FR-S520E-3.7K (-C)	M4	1.5	5.5-4	5.5-4	3.5	3.5	12	12	4	2.5

2) Three-phase 400V power input

Applied Inverter	Terminal Screw size	Tightening Torque N·m	Crimping Terminal		Cable Size					
					HIV cable (mm ²)		AWG		PVC cable (mm ²)	
					R, S, T	U, V, W	R, S, T	U, V, W	R, S, T	U, V, W
FR-S540E-0.4K to 3.7K	M4	1.5	2-4	2-4	2	2	14	14	2.5	2.5

3) Single-phase 200V power input

Applied Inverter	Terminal Screw size	Tightening Torque N·m	Crimping Terminal		Cable					
					HIV cable (mm ²)		AWG		PVC Cable (mm ²)	
					R, S	U, V, W	R, S	U, V, W	R, S	U, V, W
FR-S520SE-0.1K to 0.75K	M3.5	1.2	2-3.5	2-3.5	2	2	14	14	2.5	2.5
FR-S520SE-1.5K	M4	1.5	2-4	2-4	2	2	14	14	2.5	2.5

4) Single-phase 100V power input

Applied Inverter	Terminal Screw size	Tightening Torque N·m	Crimping Terminal		Cable Size					
					HIV cable (mm ²)		AWG		PVC cable (mm ²)	
					R, S	U, V, W	R, S	U, V, W	R, S	U, V, W
FR-S510WE-0.1K to 0.4K	M3.5	1.2	2-3.5	2-3.5	2	2	14	14	2.5	2.5
FR-S510WE-0.75K	M4	1.5	5.5-4	2-4	3.5	2	12	14	4	2.5

● Wiring length

100m maximum. (50m maximum for the FR-S540E-0.4K.)

CAUTION

- When the wiring length of the 0.1K and 0.2K of the three-phase 200V, single-phase 200V, and single-phase 100V class and the 0.4K and 0.75K of the three-phase 400V class is 30m or more, set the carrier frequency to 1kHz.
- When automatic torque boost is selected in Pr. 98 "automatic torque boost selection (motor capacity)", the wiring length should be 30m maximum. (Refer to page 60.)

3.3 Control circuit

3.3.1 Explanation of control circuit terminals

Symbol		Terminal Name	Definition	
Contact input	STF	Forward rotation start	Turn on the STF signal to start forward rotation and turn it off to stop.	When the STF and STR signals are turned on simultaneously, the stop command is given.
	STR	Reverse rotation start	Turn on the STR signal to start reverse rotation and turn it off to stop.	
	RH RM RL	Multi-speed selection	Turn on the RH, RM and RL signals in appropriate combinations to select multiple speeds. The priorities of the speed commands are in order of jog, multi-speed setting (RH, RM, RL, REX) and AU.	The terminal functions change with input terminal function selection (Pr. 60 to Pr. 63). (*3)
Input signals	SD (*1, 6)	Contact input common (sink) (initial setting)	Common terminal for contact input terminal (sink logic) and terminal FM.	
		External transistor common (source)	When connecting the transistor output (open collector output), such as a programmable controller (PLC), when source logic is selected, connect the external power supply common for transistor output to this terminal to prevent a malfunction caused by undesirable currents.	
		24VDC power supply common	Common output terminal for 24VDC 0.1A power supply (PC terminal) Isolated from terminals 5 and SE.	
PC (*1)	External transistor common (sink) (initial setting)	When connecting the transistor output (open collector output), such as a programmable controller (PLC), when sink logic is selected, connect the external power supply common for transistor output to this terminal to prevent a malfunction caused by undesirable currents.		
	Contact input common (source)	Common terminal for contact input terminal (source logic)		
	24VDC power supply	Can be used as 24VDC 0.1A power supply.		
10	Frequency setting power supply	5VDC, Permissible load current 10mA.		

Symbol	Terminal Name	Definition		
Input signals	Frequency setting	2	Frequency setting (voltage signal) Inputting 0 to 5VDC (or 0 to 10V) provides the maximum output frequency at 5V (10V) and makes input and output proportional. Switch between 5V and 10V using Pr. 73 "0-5V, 0-10V selection". Input resistance 10kΩ. Maximum permissible input voltage 20V	
		4	Frequency setting (current signal) Input 4 to 20mADC. It is factory set at 0Hz for 4mA and at 60Hz for 20mA. Maximum permissible input current 30mA. Input resistance approximately 250Ω. Turn ON signal AU for current input. Turning the AU signal on makes voltage input invalid. Use any of Pr. 60 to Pr. 63 (input terminal function selection) to set the AU signal.	
	5	Frequency setting input common Frequency setting signal (terminal 2, 4) common terminal. (*6)		
Output signals	Open collector	A B C	Alarm output 1 changeover contact output indicates that the inverter protective function has activated and the output stopped. 230VAC 0.3A, 30VDC 0.3A. Alarm: discontinuity across B-C (continuity across A-C), Normal: continuity across B-C (discontinuity across A-C).(*5)	The function of the terminals changes according to the output terminal function selection (Pr. 64, Pr. 65). (*4)
		RUN	Inverter running Switched low when the inverter output frequency is equal to or higher than the starting frequency (factory set to 0.5Hz variable). Switched high during stop or DC injection brake operation. (*2) Permissible load 24VDC 0.1A (a voltage drop is 3.4V maximum when the signal is on)	
	SE	Open collector common Common terminal for inverter running terminal RUN. (*6)		
	Indicator	FM	For meter The output signal across terminals FM-SD is factory set to about 1mA at 60Hz and is proportional to the corresponding output frequency. Since output voltage is pulse waveform, a digital meter can be connected. Frequency permissible load current 1mA Pulse specification 1440 pulses/s at 60Hz	
Communication	—	RS-485 connector Using the parameter unit connection cable (FR-CB201 to 205), the parameter unit (FR-PU04) can be connected. Communication operation can be performed using RS-485. For details of RS-485 communication, refer to the separately available instruction manual (detailed).		

- *1. Do not connect terminals SD and PC each other or to the earth (ground).
For sink logic (factory setting), terminal SD acts as the common terminal of contact input. For source logic, terminal PC acts as the common terminal of contact input. (Refer to the separately available instruction manual (detailed) for switching method.)
- *2. Low indicates that the open collector output transistor is on (conducts). High indicates that the transistor is off (does not conduct).
- *3. RL, RM, RH, RT, AU, STOP, MRS, OH, REX, JOG, RES, X14, X16, (STR) signal selection (Refer to page 57.)
- *4. RUN, SU, OL, FU, RY, Y12, Y13, FDN, FUP, RL, Y93, Y95, LF, ABC signal selection (Refer to page 57.)
- *5. To be compliant with the European Directive (Low Voltage Directive), the operating capacity of relay outputs (A, B, C) should be 30VDC 0.3A.
- *6. Terminals SD, SE and 5 are isolated from each other. Do not earth (ground).

3.3.2 Arrangement and wiring of control circuit terminals

Control circuit terminal block

PC	SE	RUN	10	2	5	4
----	----	-----	----	---	---	---

SD	SD	STF	STR	RL	RM	RH	FM
----	----	-----	-----	----	----	----	----

A	B	C
---	---	---

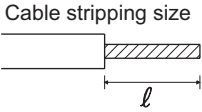

Cable stripping size

Loosen the terminal screw and insert the cable into the terminal.

- ☞ Screw size: M3 (A, B, C terminals), M2 (other than the above)
- ☞ Tightening torque: 0.5N•m to 0.6N•m (A, B, C terminals)
0.22N•m to 0.25N•m (other than the above)

CAUTION

Undertightening can cause cable disconnection or malfunction. Overtightening can cause a short circuit or malfunction due to damage to the screw or unit.

- ☞ Cable size: 0.3mm² to 0.75mm²
- ☞ Screwdriver: Small ⊖ flat-blade screwdriver
Tip thickness: 0.4mm
Tip width: 2.5mm

	l
ABC terminals	6mm
Other than the above	5mm

Wire the stripped cable after twisting it to prevent it from becoming loose.
In addition, do not solder it. *

*Information on bar terminals
Introduced products (as of September, 2006): Phoenix Contact Co.,Ltd.

Terminal Screw Size	Bar Terminal Model (With Insulation Sleeve)	Bar Terminal Model (Without Insulation Sleeve)	Wire Size (mm ²)
M3 (A, B, C terminal)	Al 0,5-6 WH	A 0,5-6	0.3 to 0.5
	Al 0,75-6 GY	A 0,75-6	0.5 to 0.75
M2 (Other than the above)	Al 0,5-6 WH	A 0,5-6	0.3 to 0.5

☞ Bar terminal crimping tool: CRIMPFOX ZA3 (Phoenix Contact Co., Ltd.)

CAUTION

When using the bar terminal (without insulation sleeve), use care so that the twisted wires do not come out.

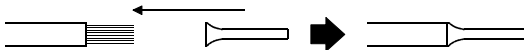

3.3.3 Connection to RS-485 connector

- (1) When connecting the parameter unit
Use the optional FR-CB2□□. When the parameter unit (FR-PU04) is used, operation from the operation panel is not accepted. ( is valid)
- (2) RS-485 communication
Using the RS-485 connector, you can perform communication operation from a personal computer etc. By connecting the RS-485 connector to computers such as personal computer and FA with a communication cable, you can run/monitor the inverter and read/write parameter values using a user program. For further details, refer to the instruction manual (detailed).
 - Conforming standard: EIA-485 (RS-485)
 - Transmission format: Multi-drop link
 - Communication speed: Maximum 19200 bps
 - Overall extension: 500m

CAUTION

Do not plug the connector to a computer LAN board, fax modem socket, telephone modular connector etc. The inverter and machine could be damaged due to differences in electrical specifications.

3.3.4 Changing the control logic

The input signals are set to sink logic.

To change the control logic, the jumper connector under the setting dial must be moved to the other position.

- Change the jumper connector position using tweezers, a pair of long-nose pliers etc. Change the jumper connector position before switching power on.

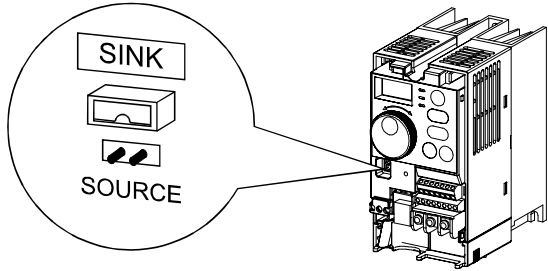

CAUTION

- Make sure that the front cover is installed securely.
- The front cover is fitted with the capacity plate and the inverter unit with the rating plate. Since these plates have the same serial numbers, always replace the removed cover onto the original inverter.
- The sink-source logic change-over jumper connector must be fitted in only one of those positions. If it is fitted in both positions at the same time, the inverter may be damaged.

1) Sink logic type

- In this logic, a signal switches on when a current flows from the corresponding signal input terminal.

Terminal SD is common to the contact input signals. Terminal SE is common to the open collector output signals.

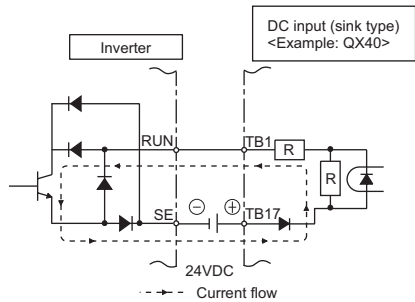
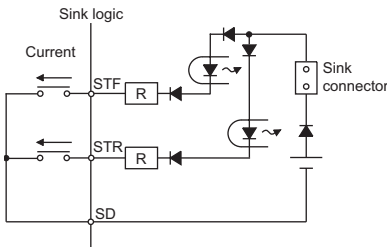

- Use terminal PC as a common terminal, and perform wiring as shown on the right. (Do not connect terminal SD of the inverter with terminal 0V of the external power supply. When using terminals PC-SD as a 24VDC power supply, do not install a power supply in parallel in the outside of the inverter. Doing so may cause a malfunction due to undesirable current.)

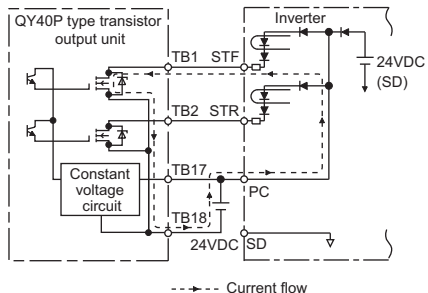

2) Source logic type

- In this logic, a signal switches on when a current flows into the corresponding signal input terminal.

Terminal PC is common to the contact input signals. For the open collector output signals, terminal SE is a positive external power supply terminal.

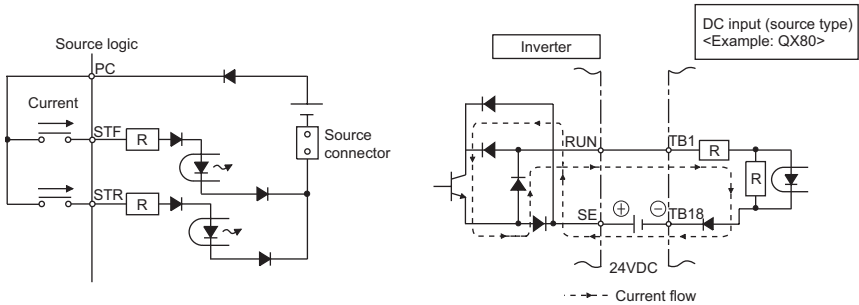

- Use terminal SD as a common terminal, and perform wiring as shown on the right. (Do not connect terminal PC of the inverter with terminal +24V of the external power supply. When using terminals PC-SD as a 24VDC power supply, do not install an external power supply in parallel with the inverter. Doing so may cause a malfunction in the inverter due to undesirable currents.)

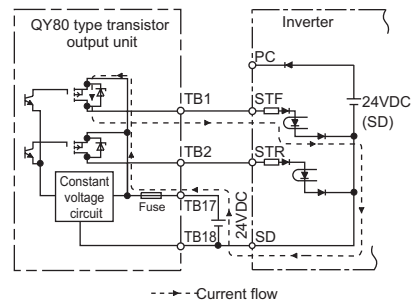

3.3.5 Power-off and magnetic contactor (MC)

(1) Inverter input side magnetic contactor (MC)

On the inverter's input side, it is recommended to provide an MC for the following purposes. (Refer to page 4 for selection)

1) To release the inverter from the power supply when the inverter protective function is activated or the drive becomes faulty (e.g. emergency stop operation)

When cycle operation or heavy-duty operation is performed with an optional brake resistor connected, overheat and burnout of the electrical-discharge resistor can be prevented if a regenerative brake transistor is damaged due to insufficient heat capacity of the electrical-discharge resistor and excess regenerative brake duty.

2) To prevent any accident due to an automatic restart at restoration of power after an inverter stop made by a power failure

3) To rest the inverter for an extended period of time

The control power supply for inverter is always running and consumes a little power. When stopping the inverter for an extended period of time, powering off the inverter will save power slightly.

4) To separate the inverter from the power supply to ensure safe maintenance and inspection work

The inverter's input side MC is used for the above purpose, select class JEM1038-AC3 for the inverter input side current when making an emergency stop during normal operation.

REMARKS

The MC may be switched on/off to start/stop the inverter. However, since repeated inrush currents at power on will shorten the life of the converter circuit (switching life is about 100,000 times), frequent starts and stops must be avoided. Turn on/off the inverter start controlling terminals (STF, STR) to run/stop the inverter.

As shown on the right, always use the start signal (ON or OFF across terminals STF or STR-SD) to make a start or stop.

*1. When the power supply is 400V class, install a step-down transformer.

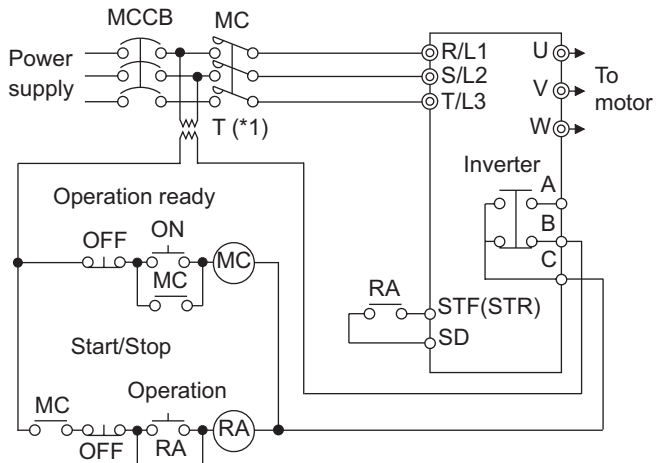

Inverter Start/Stop Circuit Example

(2) Handling of output side magnetic contactor

In principle, do not provide a magnetic contactor between the inverter and motor and switch it from off to on during operation. If it is switched on during inverter operation, a large inrush current may flow, stopping the inverter due to overcurrent shut-off. When an MC is provided for switching to the commercial power supply, for example, switch it on/off after the inverter and motor have stopped.

3.4 Failsafe of the system which uses the inverter

When a fault occurs, the inverter trips to output an alarm. However, an alarm output signal may not be output at an inverter alarm occurrence when the detection circuit or output circuit fails, etc. Although Mitsubishi assures best quality products, provide an interlock which uses inverter status output signals to prevent accidents such as damage to machine when the inverter fails for some reason and at the same time consider the system configuration where failsafe from outside the inverter, without using the inverter, is enabled even if the inverter fails.

(1) Interlock method which uses the inverter status output signals

By combining the inverter status output signals to provide an interlock as shown below, an inverter alarm can be detected.

No	Interlock Method	Check Method	Used Signals	Refer to Page
1)	Inverter protective function operation	Operation check of an alarm contact Circuit error detection by negative logic	Alarm output signal (ABC signal)	Refer to the chapter 2 of the Instruction Manual (detailed)).
2)	Inverter running status	Operation ready signal check	Operation ready signal (RY signal)	Refer to the chapter 2 of the Instruction Manual (detailed)).
3)	Inverter running status	Logic check of the start signal and running signal	Start signal (STF signal, STR signal) Running signal (RUN signal)	Refer to the chapter 2 of the Instruction Manual (detailed)).
4)	Inverter running status	Logic check of the start signal and output current	Start signal (STF signal, STR signal) Output current detection signal (Y12 signal)	Refer to the chapter 2 of the Instruction Manual (detailed)).

(2) Backup method outside the inverter

Even if the interlock is provided by the inverter status signal, enough failsafe is not ensured depending on the failure status of the inverter itself. For example, even if the interlock is provided using the inverter alarm output signal, start signal and RUN signal output, there is a case where an alarm output signal is not output and RUN signal is kept output even if an inverter alarm occurs.

Provide a speed detector to detect the motor speed and current detector to detect the motor current and consider the backup system such as checking up as below according to the level of importance of the system.

1) Start signal and actual operation check

Check the motor running and motor current while the start signal is input to the inverter by comparing the start signal to the inverter and detected speed of the speed detector or detected current of the current detector. Note that the motor current runs as the motor is running for the period until the motor stops since the inverter starts decelerating even if the start signal turns off. For the logic check, configure a sequence considering the inverter deceleration time. In addition, it is recommended to check the three-phase current when using the current detector.

2) Command speed and actual operation check

Check if there is no gap between the actual speed and commanded speed by comparing the inverter speed command and detected speed of the speed detector.

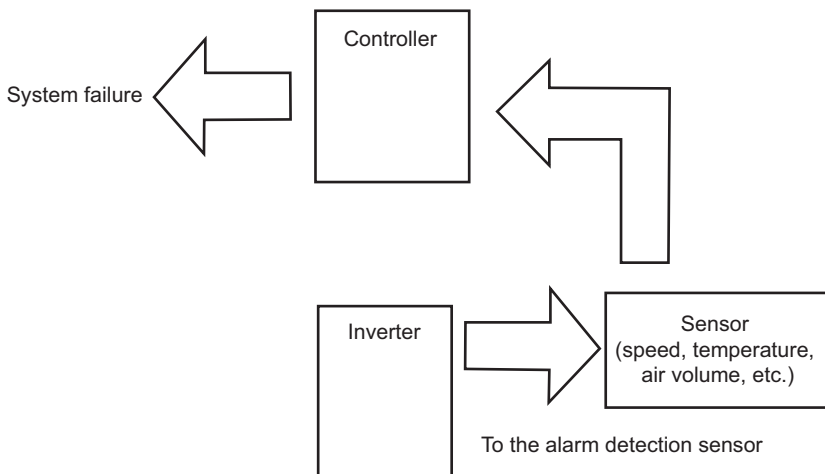

4. DRIVE THE MOTOR

4.1 Step of operation

The inverter needs frequency command and start command. Turning the start command on start the motor rotating and the motor speed is determined by the frequency command.

Refer to the flow chart below to perform setting.

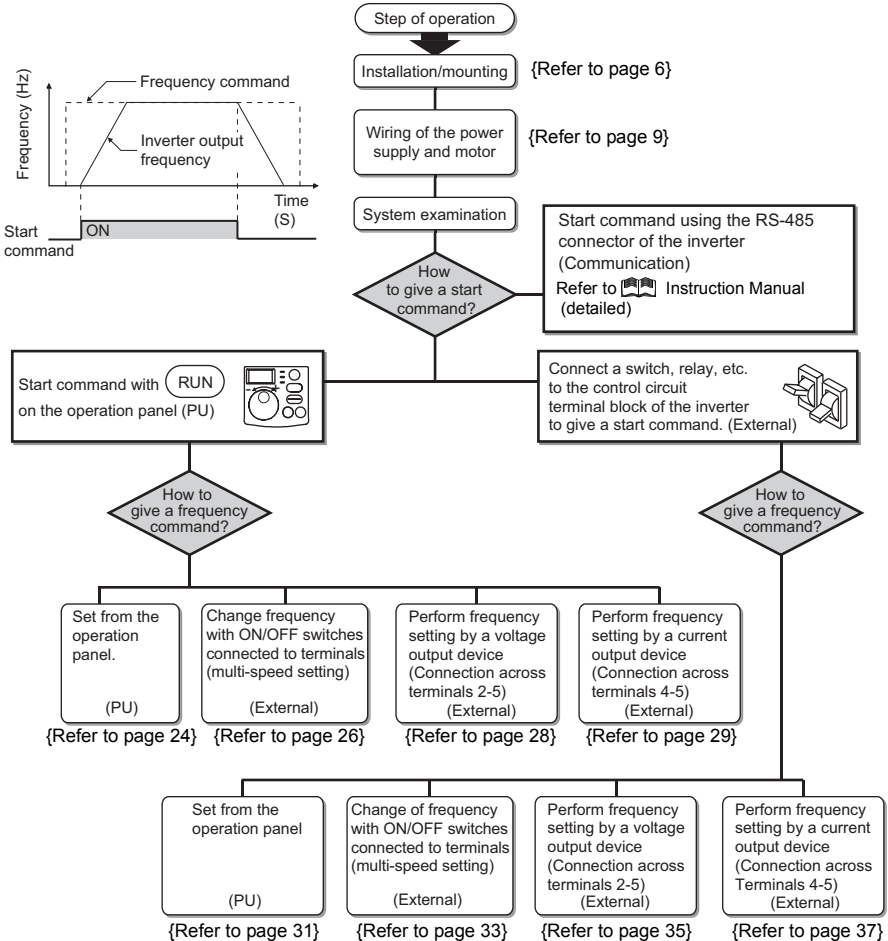

CAUTION

Check the following items before powering on the inverter.

- Check that the inverter is installed correctly in a correct place. (Refer to page 6)
- Check that wiring is correct. (Refer to page 7)
- Check that no load is connected to the motor.

4.2 Run and operation

4.2.1 Parts of the operation panel

The operation panel cannot be removed from the inverter.

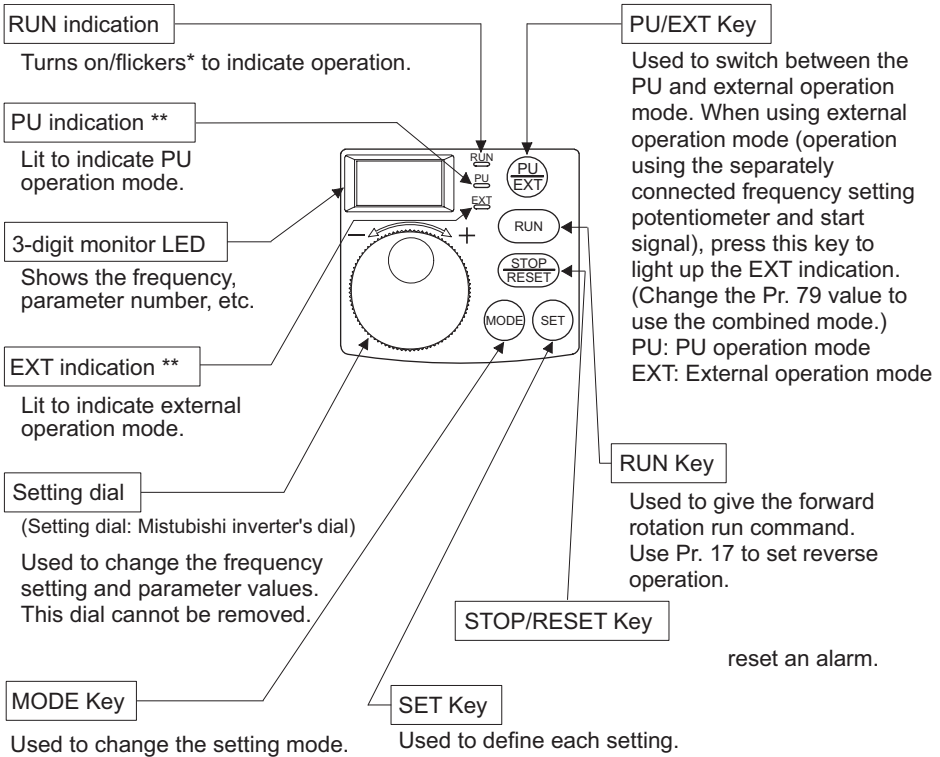

*** RUN indication**

On: Indicates that forward rotation operation is being performed.

Slow flickering (1.4s cycle): Indicates reverse rotation

Fast flickering (0.2s cycle): Indicates that operation is not being performed

but the **(RUN)** was pressed or the start command was given.

When the start command is given and the frequency command is less than the strating frequency.

**** PU/EXT indication**

Flickers slowly in the computer link operation mode.

REMARKS

- When the parameter unit (FR-PU04) is used, operation from the operation panel is not accepted. (**(STOP/RESET)** is valid)

4.2.2 Basic operation

The following explains the outline of operation. (factory setting)

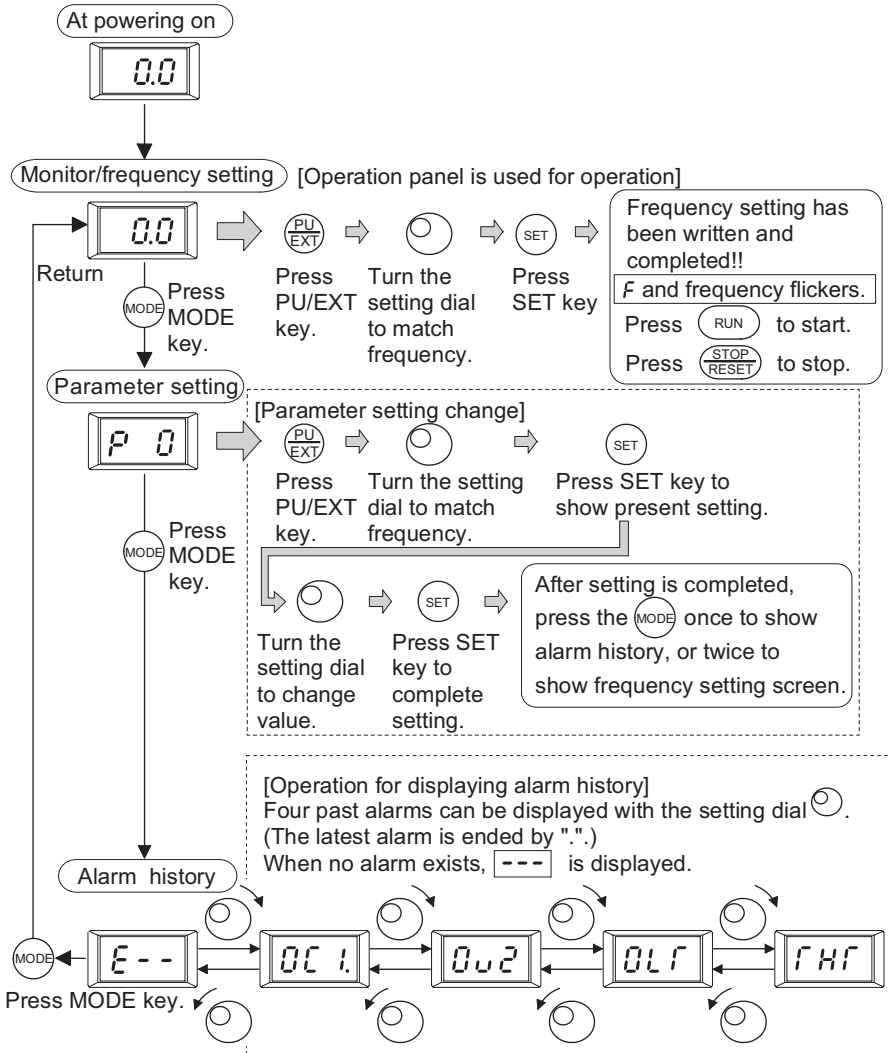

4.3 Operation by the start command from the operation panel (PU operation mode)

4.3.1 Setting the frequency to perform operation (example: performing operation at 30Hz)

POINT

- Set "0" (setting dial frequency setting mode) in Pr. 53 "frequency setting operation selection".

- | Operation | | Display |
|---|---|--|
| 1. Screen at power-on
The monitor display appears. | | |
| 2. Press the to choose PU operation mode. | → | PU indication is lit. |
| 3. Turn the to show the frequency you want to set.
Flickers for about 5s. | → | Flickers for about 5s. |
| 4. While the value is flickering, press the to set the frequency. | → | Flicker...Frequency setting complete!! |
| <p>If you do not press the , the value flickers for about 5s and the display then returns to 0.0 (monitor display). At this time, return to "step 3" and set the frequency again.</p> | | |
| 5. After the value flickered for about 3s, the display returns to 0.0 (monitor display).
Press the to start operation. | → | ↓3s later → |
| 6. To change the set frequency, perform the operation in above steps 3 and 4.
(Starting from the previously set frequency.) | | |
| 7. Press the to stop. | → | → |

? Operation cannot be performed at the set frequency ... Why?

- ☞ Did you carry out step 4 within 5s after step 3?

(Did you press the within 5s after turning the setting dial?)

? Setting of higher than 60Hz cannot be made ... Why?

- ☞ Check to see if the Pr. 1 "maximum frequency" setting is 60Hz.

? The frequency does not change by turning the setting dial ... Why?

- ☞ Check to see if the operation mode selected is external operation mode.

REMARKS

Pressing the setting dial shows the set frequency.



- The setting dial can also be used like a potentiometer to perform operation. (Refer to page 25.)

4.3.2 Using the setting dial like a potentiometer to perform operation

POINT

- Set "1" (extended function parameter valid) in Pr. 30 "extended function display selection".
- Set "1" (setting dial potentiometer mode) in Pr. 53 "frequency setting operation selection".

Operation example Changing the frequency from 0Hz to 60Hz during operation

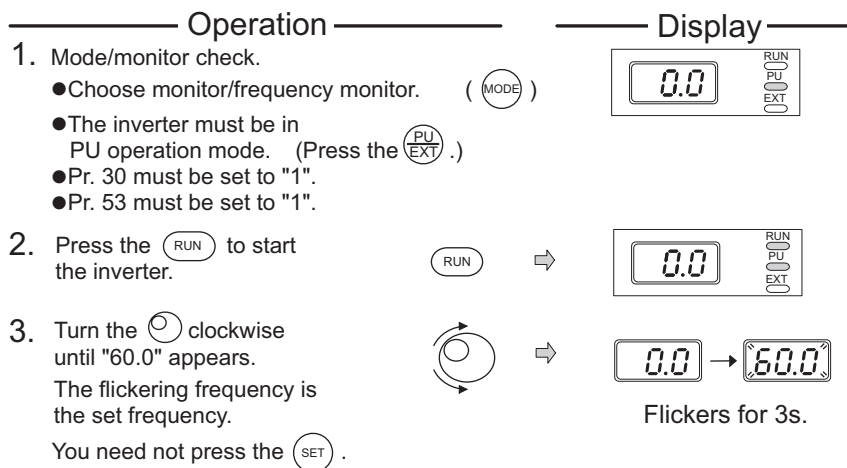

REMARKS

- If flickering "60.0" turns to "0.0", the Pr. 53 "frequency setting operation selection" setting may not be "1".
- Independently of whether the inverter is running or at a stop, the frequency can be set by merely turning the dial.

4.3.3 Use switches to give a start command and a frequency command (multi-speed setting)

POINT

- Use **(RUN)** to give a start command.
- Pr. 79 "operation mode selection" must be set to "4" (external/PU combined operation mode 2)
- The factory setting of the terminal RH, RM, RL, are 60Hz, 30Hz, and 10Hz. (Refer to page 47 to change frequency using Pr. 4, Pr. 5 and Pr. 6.)
- Operation at 15-speed can be performed by turning on two (or three) terminals simultaneously. (Refer to Instruction Manual (detailed).)

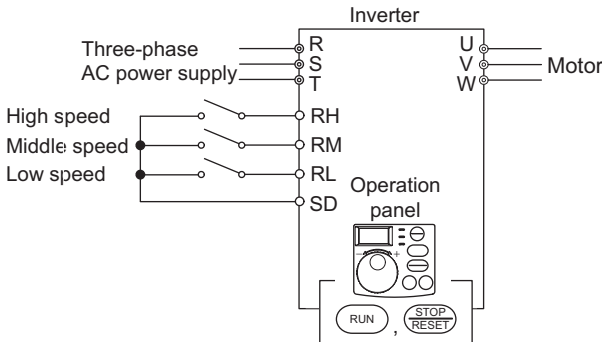

Operation

1. Screen at powering on
The monitor display appears.
2. Press **(MODE)** to choose the parameter setting mode.
3. Turn until **P79** (Pr. 79) appears.
4. Press **(SET)** to read the currently set value.
"0" (factory setting) appears.
5. Turn to change it to the setting value of "4".
6. Press **(SET)** to set.

Display



(The parameter number read previously appears.)



Flicker ... Parameter setting complete!!

7. Mode/monitor check

Press  twice to choose the monitor/frequency monitor.



8. Press the start switch .

RUN flickers.
When the frequency command is not given, it flickers.



Low speed

9. Turn on the low speed switch (RL).

The output frequency increases to 10Hz according to Pr. 7 "acceleration time".

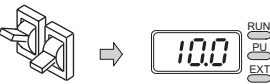

10. Turn off the low speed switch (RL).

The output frequency decreases to 0Hz according to Pr. 8 "deceleration time".





11. Turn off the start switch .

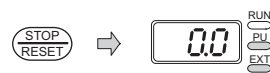

RUN turns off.



? **60Hz for the RH, 30Hz for the RM, 10Hz for the RL are not output when they are turned on ... Why?**

-  Check for the setting of Pr. 4, Pr. 5, and Pr. 6 once again.
-  Check for the setting of Pr. 1 "maximum frequency" and Pr. 2 "minimum frequency" once again. (Refer to page 47.)
-  Check that Pr. 60 "RL terminal function selection" = "0", Pr. 61 "RM terminal function selection" = "2", Pr. 62 "RH terminal function selection" and Pr. 59 "remote function selection" = "0". (all are factory setting)

? **[RUN] lamp is not lit ... Why?**

-  Check that wiring is correct. Check the wiring once again.
-  Check for the Pr. 79 setting once again. (Pr. 79 must be set to "4".) (Refer to page 47)

? **Change the frequency of the terminal RL, RM, and RH. ...How?**

-  Refer to page 47 to change the running frequency at each terminal in Pr. 4 "multi-speed setting (high speed)", Pr. 5 "multi-speed setting (middle speed)", and Pr. 6 "multi-speed setting (low speed)".

4.3.4 Perform frequency setting by analog (voltage input)

POINT

- Use **RUN** to give a start command.
- Pr. 79 "operation mode selection" must be set to "4" (external/PU combined operation mode 2)

[Connection diagram]

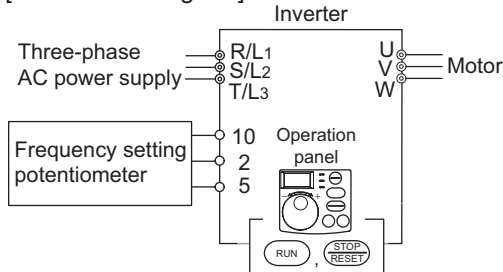

Operation

1. Screen at powering on
The monitor display appears.
2. Change the Pr. 79 setting to "4".
(Refer to page 26 for change of the setting.)
3. Mode/monitor check
Press **MODE** twice to choose the monitor/frequency monitor.
4. Start
Press the start switch **RUN**.
Operation status indication of RUN flickers.
5. Acceleration → constant speed
Turn the potentiometer (frequency setting potentiometer) clockwise slowly to full.
The frequency value on the indication increases according to Pr. 7 "acceleration time" until 60.00Hz is displayed.
6. Deceleration
Turn the potentiometer (frequency setting potentiometer) counterclockwise slowly to full.
The frequency value on the indication decreases according to Pr. 8 "deceleration time" until 0.00Hz is displayed and operation status indication of RUN flickers.
The motor stops.
7. Stop
Press **STOP/RESET**.
Operation status indication of RUN turns off.

Display



Flicker ... Parameter setting complete

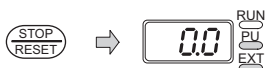
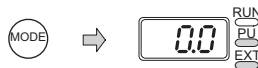

? Change the frequency (60Hz) of the maximum value of potentiometer (at 5V)

☞ Adjust the frequency in Pr. 38 "frequency setting voltage gain frequency".
(Refer to page 43)

? Change the frequency (0Hz) of the minimum value of potentiometer (at 0V)

☞ Adjust the frequency in calibration parameter C2 "frequency setting voltage bias frequency". (Refer to Instruction Manual (detailed).)

4.3.5 Perform frequency setting by analog (current input)

POINT

- Assign the AU signal to any of the terminal RH, RM, RL, or STR and turn on the AU signal.
- Pr. 62 and Pr. 39 are extended function parameters. Set "1" in Pr. 30. (Refer to page 51.)
- Set "4" (external/PU combined operation mode 2) in Pr. 79 "operation mode"

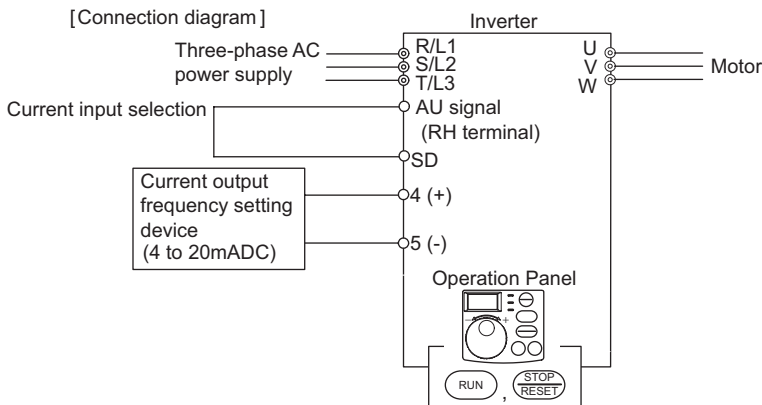

[AU signal assignment]

- Assign the AU signal to any of the RL, RM, RH or STR terminal.
(example) Assign the AU signal to the RH terminal.
Set "4" (AU signal) in Pr. 62 "RH terminal function selection".

Operation

Display

1. Confirm the RUN indication and operation mode indication.
 - The inverter must be at a stop.
 - The inverter must be in the PU operation mode. (Press the PU/EXT .)
2. Press the MODE to choose the parameter setting mode.
3. Turn the CLOCK until $P62$ (Pr. 62) appears.
4. Press the SET to read the currently set value.
"2" (factory setting) appears.
5. Turn the CLOCK to change it to the set value of "4".
6. Press the SET to set the value.

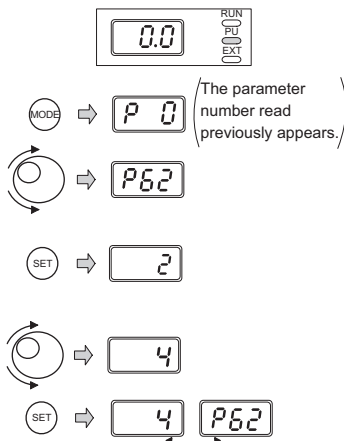

Flicker...AU signal assignment complete!!

REMARKS

- Refer to page 49, 54 for other parameters' setting.
- Refer to page 57 for details of Pr. 62 "RH terminal function selection".

[Perform frequency setting by analog (current input)]

Operation

Display

7. Change the Pr. 79 setting to "4".
(Refer to page 26 for change of the setting.)



Flicker ... Parameter setting complete!!

8. Mode/monitor check

Press **MODE** twice to choose the monitor/frequency monitor.



9. Start

Check that the current input selection signal (AU) is on.

Press the start switch **RUN**.

RUN of operation status indication flickers.



10. Acceleration → constant speed

Perform 20mA input.

The frequency value on the indication increases according to Pr. 7 "acceleration time" until 60.00Hz is displayed.

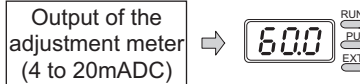

11. Deceleration

Perform 4mA input.

The frequency value on the indication decreases according to Pr. 8 "deceleration time" until 0.00Hz is displayed and the operation status indication of RUN flickers.

The motor stops.

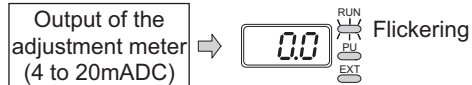

12. Stop

Press **STOP/RESET**.

RUN of the operation status indication turns off.

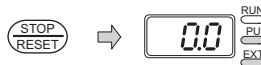

? Change the frequency (60Hz) at the maximum value of potentiometer (at 20mV)

☞ Adjust the frequency in Pr. 39 "frequency setting current gain frequency".
(Refer to page 44)

? Change the frequency (0Hz) at the minimum value of potentiometer (at 4mA)

☞ Adjust the frequency in calibration parameter C5 "frequency setting current bias frequency". (Refer to Instruction Manual (detailed).)

4.4 Operation by the start command of the terminal block (external operation)

4.4.1 Use the set frequency set by the operation panel (Pr. 79 = 3)

POINT

- Switch terminal STF(STR)-SD on to give a start command.
- Set "3" in Pr. 79 (External/PU combined operation mode 1).
- Refer to page 24 for the set frequency by the operation panel.

[Connection diagram]

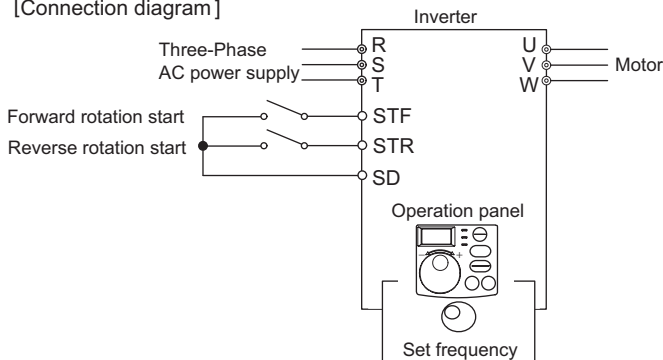

Operation

1. Screen at powering on
The monitor display appears.
2. Press **MODE** to choose the parameter setting mode.
3. Turn **◀▶** until **P 79** (Pr. 79) appears.
4. Press **SET** to read the currently set value.
"0" (factory setting) appears.
5. Turn **◀▶** to change it to the setting value of "3".
6. Press **SET** to set.

Display

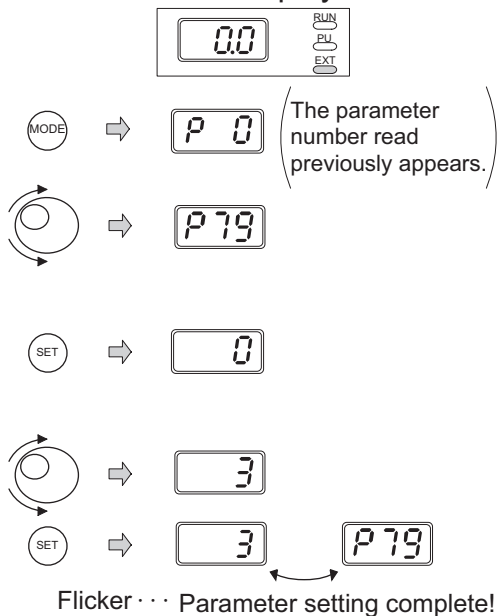

7. Mode/monitor check

Press **MODE** twice to choose the monitor/frequency monitor.



8. Turn the start switch (STF or STR) on.

● The motor runs at the frequency set in the set frequency mode of the operation panel.

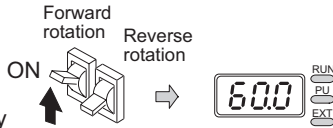

9. Turn to change running frequency. Display the frequency you want to set. The frequency flickers for about 5s.



10. While the value is flickering, press **SET** to set the frequency.

(If you do not press **SET**, the value flickers for about 5s and the display then returns to 0.00 (display) Hz. At this time, return to "Step 8" and set the frequency again.)



11. Turn the start switch (STF or STR) off.

The motor decelerates according to Pr. 8 "deceleration time" to stop.

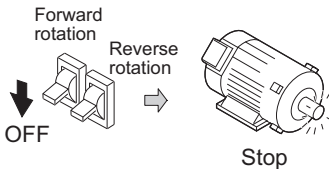

REMARKS

- To make a reverse rotation start, Pr. 63 "STR terminal function selection" must be set to "---" (factory setting)
- When Pr. 79 "operation mode selection" is set to "3", multi-speed operation (refer to page 33) is also made valid.

? When the inverter is stopped by **STOP/RESET** of the operation panel,

PS and **0.0**  Flickering **are displayed alternately.**

☞ 1. Turn the start switch (STF or STR) off.

☞ 2. The display can be reset by **PU/EXT**.

4.4.2 Use switches to give a start command and a frequency command (multi-speed setting)

POINT

- Start command by terminal STF (STR)-SD
- Frequency command by terminal RH, RM, RL-SD.
- [EXT] must be lit. (When [PU] is lit, switch it to [EXT] with PU/EXT .)
- The initial values of the terminals RH, RM, RL, are 60Hz, 30Hz, and 10Hz. (Use Pr. 4, Pr. 5, and Pr. 6 to change.)
- Operation at 15-speed can be performed by turning two (or three) terminals simultaneously. (Refer to the instruction Manual(detailed).)

[Connection diagram]

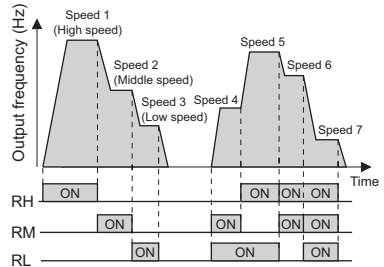
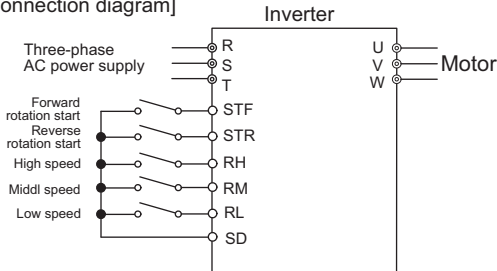

Changing example Set "50Hz" in Pr. 4 "multi-speed setting (high speed)" and turn on terminal RH and STF (STR)-SD to operate.

Operation

1. Power on → operation mode check
For the factory setting, the inverter operates in the external operation mode [EXT] when powering on. Check that the operation command indication is [EXT].
If not displayed, press PU/EXT to change to the external [EXT] operation mode. If the operation mode still does not change, set Pr. 79 to change to the external operation mode. (Refer to page 49)
2. Press MODE to choose the parameter setting mode.
3. Turn ▲ until **P 4** (Pr. 4) appears.
4. Press SET to read the currently set value.
"60.0" (factory setting) appears. (60.0Hz)

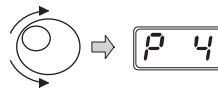
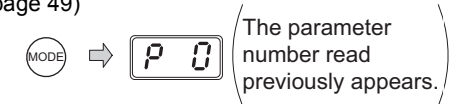
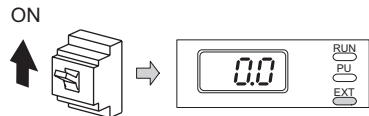

5. Turn  to change it to the setting value of "50.0". (50.0Hz)



6. Press  to set.



Flicker . . . Parameter setting complete!!

7. Mode/monitor check

Press  twice to choose the monitor/frequency monitor.



8. Turn on the high speed switch (RH).

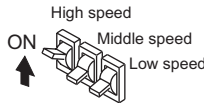

9. Turn the start switch (STF or STR) on.
50Hz appears.

● 30Hz appears when RM is on and 10Hz appears when RL is on.

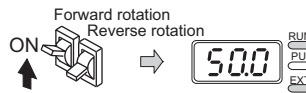

10. Stop

Turn the start switch (STF or STR) off.
The motor stops according to Pr. 8 "deceleration time".

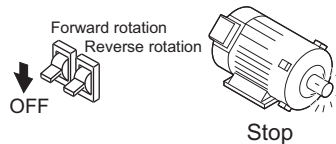

? [EXT] is not lit even when  is pressed ...Why?

☞ Switchover of the operation mode with  is valid when Pr. 79 = "0" (initial value).

? 60Hz, 30Hz and 10Hz are not output from RH, RM and RL respectively when they are turned on. ...Why?

- ☞ Check for the setting of Pr. 4, Pr. 5, and Pr. 6 once again.
- ☞ Check for the setting of Pr. 1 "maximum frequency" and Pr. 2 "minimum frequency" once again. (Refer to page 47)
- ☞ Check for the Pr. 79 setting once again. (Pr. 79 must be set to "0" or "2".) (Refer to page 47)
- ☞ Check that Pr. 60 "RL terminal function selection" = "0", Pr. 61 "RM terminal function selection" = "1", Pr. 62 "RH terminal function selection" = "2" and Pr. 59 "remote function selection" = "0". (factory setting)

? [RUN] is not lit. ...Why?

- ☞ Check that wiring is correct. Check it again.
- ☞ To make a reverse rotation start, check that "---" is set in Pr. 63 "STR terminal function selection"? (factory setting)

? How is the frequency setting from 4 to 7 speed?

- ☞ The setting differs according to Pr. 24 to Pr. 27 (multi-speed setting). Refer to  Instruction Manual (detailed).

REMARKS

External operation is fixed by setting "2" (external operation mode) in Pr. 79 "operation mode selection" when you do not want to take time pressing  or when you want to use the current operation command and frequency command. (Refer to page 49)

4.4.3 Perform frequency setting by analog (voltage input)

[Connection diagram]

(The inverter supplies 5V of power to frequency setting potentiometer. (Terminal 10))

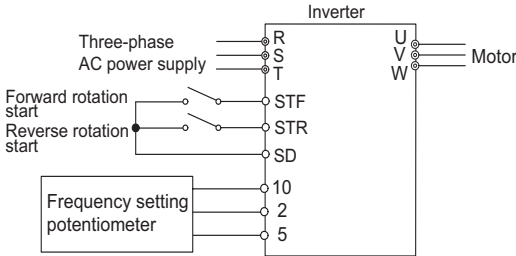

Operation

- Power on → operation mode check
For the factory setting, the inverter operates in the external operation mode [EXT] when powering on. Check that the operation command indication is [EXT]. If not displayed, press PU/EXT to change to the external [EXT] operation mode. If the operation mode still does not change, set Pr. 79 to change to the external operation mode. (Refer to page 49)

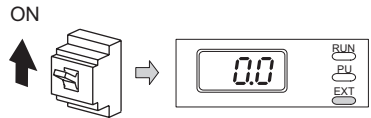

- Start
Turn the start switch (STF or STR) on.
Operation status indication of RUN flickers.

CAUTION

When both the forward switch and reverse switch are on, the inverter will not start. Also, if both switches turn on while running, the inverter decelerates to stop.

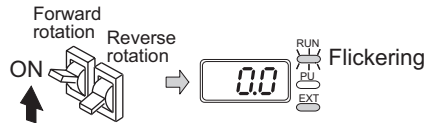

- Acceleration → constant speed
Turn the potentiometer (frequency setting potentiometer) clockwise slowly to full. The frequency value on the indication increases according to Pr. 7 "acceleration time" until 60.0Hz is displayed.



- Deceleration
Turn the potentiometer (frequency setting potentiometer) counterclockwise slowly to full. The frequency value of the indication decreases according to Pr. 8 "deceleration time" until 0.0Hz is displayed. The motor stops.



- Stop
Turn the start switch (STF or STR) off.

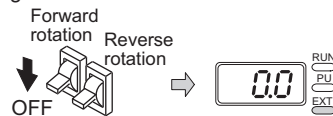

When you want to operate in the external operation mode always at powering on or when you want save the trouble of PU/EXT input, set "2" (external operation mode) in Pr. 79 "operation mode selection" to choose external operation mode always.

REMARKS

To make a reverse rotation start, Pr. 63 "STR terminal function selection" must be set to "---".

? The motor will not rotate ... Why?

☞ Check that [EXT] is lit.
[EXT] is valid when Pr. 79 = "0" (factory setting).

Use $\frac{PU}{EXT}$ to lit [EXT].

☞ Check that wiring is correct. Check once again.

? Change the frequency (60Hz) of the maximum value of potentiometer (at 5V)

☞ Adjust the frequency in Pr. 38 "frequency setting voltage gain frequency".
(Refer to page 43)

? Change the frequency (0Hz) of the minimum value of potentiometer (at 0V)

☞ Adjust the frequency in calibration parameter C2 "frequency setting Voltage bias frequency". (Refer to  Instruction Manual (detailed).)

4.4.4 Perform frequency setting by analog (current input)

POINT

- Switch terminal STF(STR)-SD on to give a start command.
- Assign the AU signal to any of the terminal RH, RM, RL, or STR and turn on the AU signal. (Refer to page 29)
- Set "2" (external operation mode) in Pr. 79 "operation mode selection".

[Connection diagram]

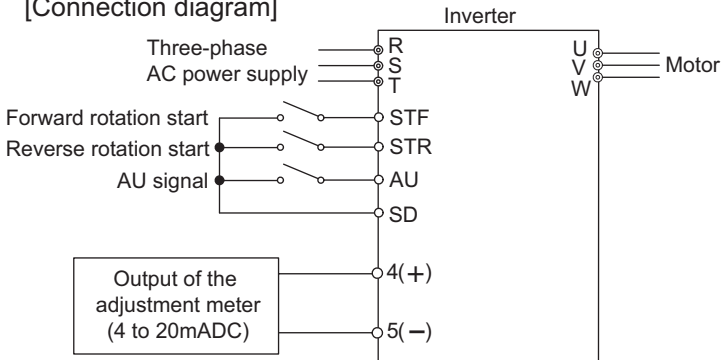

Operation

1. Power on → operation mode check
For the factory setting, the inverter operates in the external operation mode [EXT] when powering on. Check that the operation command indication is [EXT]. If not displayed, press PU/EXT to change to the external [EXT] operation mode. If the operation mode still does not change, set Pr. 79 to change to the external operation mode. (Refer to page 49)

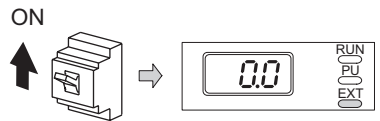

2. Start
Turn the start switch (STF or STR) on.
RUN of operation indication flickers.

CAUTION

When both the forward switch and reverse switch are on, the inverter will not start. Also, if both switches turn on while running, the inverter decelerates to stop.

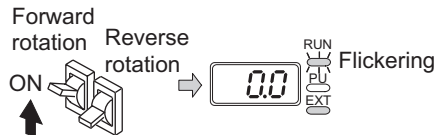

3. Acceleration → constant speed
Perform 20mA input.
The frequency value on the indication increases according to Pr. 7 "acceleration time" until 60.0Hz is displayed.

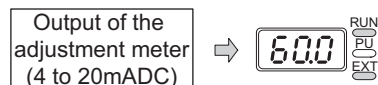

4. Deceleration
Perform 4mA input.
The frequency value on the indication decreases according to Pr. 8 "deceleration time" until 0.0Hz is displayed and RUN of the operation status indication flickers.
The motor stops.

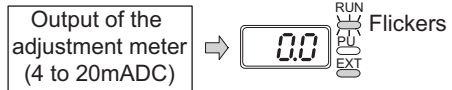

5. Stop
Turn the start switch (STF or STR) off.

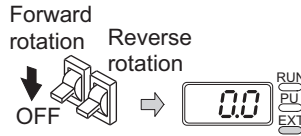

REMARKS

To make a reverse rotation start, Pr. 63 "STR terminal function selection" must be set to "---".

? The motor will not rotate ... Why?

- ☞ Check that [EXT] is lit.
[EXT] is valid when Pr. 79 = "0" (factory setting)
Use $\begin{matrix} \text{PU} \\ \text{EXT} \end{matrix}$ to lit [EXT].
- ☞ Check that the AU signal is on.
Turn the AU signal on.
- ☞ Check that wiring is correct. Check it again.

? Change the frequency (60Hz) of the maximum value of potentiometer (at 20mA)

- ☞ Adjust the frequency in Pr. 39 "frequency setting current gain frequency".
(Refer to page 44)

? Change the frequency (0Hz) of the minimum value of potentiometer (at 4mA)

- ☞ Adjust the frequency in calibration parameter C5 "frequency setting current bias frequency". (Refer to Instruction Manual (detailed).)

4.5 Clearing the parameters

POINT

- The clear parameter CLr is an extended parameter. Set "1" in Pr. 30 and turn the dial to show it. (Refer to page 51.)
- The parameters can be cleared by setting  "1" in CLr "parameter clear".

Operation ————— Display

1. Confirm the RUN indication and operation mode indication.

- The inverter must be at a stop.

- The inverter must be in PU operation mode. (Press the .)



2. Press the  to choose the parameter setting mode.



(The parameter number read previously appears.)

3. Turn the  until "CLr" appears.



- Pr. 30 must be set to "1"
(For details, refer to steps 3 to 6 on page 51.)

4. Press the  to show "0"



5. Turn  to change it to "1".





6. Press the .



Flicker...Parameter setting complete!!

- By turning the , you can read another parameter.

- Press the  to show Pr. 0 (.

CLr Setting	Definition
0	Not executed.
1	Parameter clear *1 (Calibration parameters C1 to C7 are not cleared.)
10	All clear *2 (All set values including those of calibration parameters C1 to C7 are returned to factory settings.)

*1. Parameters are not cleared when "1" is set in Pr. 77 "parameter write disable selection", Pr. 75 "reset selection/PU stop selection", Pr. 38, Pr. 39, Pr. 53, Pr. 60 to Pr. 65, Pr. 99, maintenance parameters H1, H2, calibration parameters C1 to C7 and communication parameters n13, n 15 are not cleared.

*2. Pr. 75 "reset selection/PU stop selection", maintenance parameter H1 "maintenance timer" and communication parameter n13 "PU display language selection" are not cleared.

4.6 Monitoring the output current

POINT

The output current appears while the  is pressed in the monitor mode.

Operation

Display

1. Press the  to choose the output frequency monitor mode.



2. Independently of whether the inverter is running in any operation mode or at a stop, the output current appears while the  is pressed.

 →
Hold down

 (1.0A)

3. Release the  to return to the output frequency monitor mode.

→



REMARKS

When Pr. 52 = "1", the output current is displayed in the monitor mode and the output frequency appears while the  is pressed.

5. ADJUSTMENT OF THE FREQUENCY SETTING POTENTIOMETER AND INDICATOR

●Related parameters

Parameter	Name	Setting Range	Factory Setting
38	Frequency setting voltage gain frequency	1 to 120Hz	60Hz
39	Frequency setting current gain frequency	1 to 120Hz	60Hz
C2	Frequency setting voltage bias frequency	0 to 60Hz	0Hz
C3	Frequency setting voltage bias	0 to 300%	0% *1
C4	Frequency setting voltage gain	0 to 300%	96% *1
C5	Frequency setting current bias frequency	0 to 60Hz	0Hz
C6	Frequency setting current bias	0 to 300%	20% *1
C7	Frequency setting current gain	0 to 300%	100% *1

*1. Settings may differ because of calibration parameters.

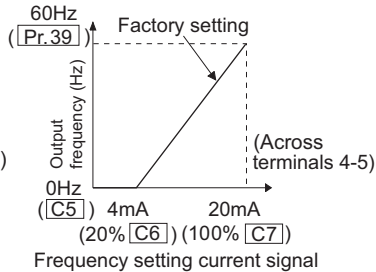
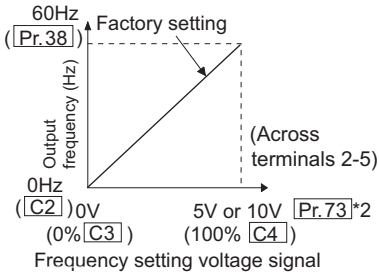

*2. Pr. 73 "0-5V/0-10V selection" changes the specifications of terminal "2".

POINT

- Bias setting for 0 to 5VDC (0 to 10VDC) input ➔ Use the calibration parameter C2, C3 for setting
- Gain setting for 0 to 5VDC (0 to 10VDC) input ➔ Use Pr. 38, calibration parameter C4 for setting.
- Bias setting for 4 to 20mADC input ➔ Use the calibration parameter C5, C6 for setting.
- Gain setting for 4 to 20mADC input ➔ Use Pr. 39, calibration parameter C7 for setting.

For 4 to 20mADC input, set "4" in any of Pr. 60 to Pr. 63 (input terminal function selection) and assign AU (current input selection) to any of terminals RH, RM, RL and STR, and turn on the AU signal.

5.1 Changing the output frequency setting of the frequency setting potentiometer (bias and gain of frequency setting voltage (current))

POINT

Pr. 38, Pr. 39 and calibration parameters "C1 to C7" can be made to be read by setting "1" (extended function parameter valid) in Pr. 30 "extended function display selection".

The bias/gain of the frequency setting voltage (current) may be adjusted in any of the following methods:

- (1) Changing the highest frequency
- (2) Adjusting the deviation of the highest frequency from the Pr. 38 (Pr. 39) setting
 - (2)-1) Make adjustment with a voltage applied across terminals 2-5 (with a current flowing across terminals 4-5)
 - (2)-2) Make adjustment at any point without a voltage applied across terminals 2-5 (without a current flowing across terminals 4-5) (For the setting method, refer to the instruction manual (detailed).)

Changing example

When you want to use the 0 to 5VDC input frequency setting potentiometer to change the 5V-time frequency from 60Hz (factory setting) to 50Hz.

POINT

- Pr. 38 is an extended function parameter. Pr. 30 must be set to "1". (Refer to page 51.)
- Change Pr. 38 "frequency setting voltage gain frequency" to 50Hz.

(1) -1) Changing the highest frequency (0 to 5V input)

Operation

Display

1. Confirm the RUN indication and operation mode indication.
 - The inverter must be at a stop.
 - The inverter must be in the PU operation mode. (Press the )



2. Press the  to choose the parameter setting mode.



(The parameter number read previously appears.)

3. Turn the  until Pr. 38 "frequency setting voltage gain frequency" appears.
 - Pr. 30 must be set to "1"
 (Refer to steps 3 to 6 on page 51 for the parameter setting method.)



4. Press the  to display the currently set value. (60Hz)





5. Turn the  to change it to "50.0". (50Hz)



6. Press the  to set the value.



Flicker...Parameter setting complete!!

- By turning the , you can read another parameter.
- Press the  to show the setting again.
- Press the  twice to show the next parameter.

? The monitor/frequency setting indication cannot be changed to just 50Hz ...Why?

 The calibration parameter C4 "frequency setting voltage gain" value must be set. (Refer to page 45.)

REMARKS

To change the value to more than 60Hz, Pr. 1 "maximum frequency" must be set to more than 60Hz.

Changing example

When you want to use the 4 to 20ADC input frequency setting potentiometer to change the 20mA-time frequency from 60Hz (factory setting) to 50Hz.

POINT

- Pr. 39 is an extended function parameter. Pr. 30 must be set to "1". (Refer to page 51.)
- Change Pr. 39 "frequency setting current gain frequency" to 50Hz.

(1) -2) Changing the highest frequency (4 to 20mA input)

Operation

Display

1. Confirm the RUN indication and operation mode indication.
 - The inverter must be at a stop.
 - The inverter must be in the PU operation mode. (Press the $\begin{matrix} \text{PU} \\ \text{EXT} \end{matrix}$)



2. Press the MODE to choose the parameter setting mode.

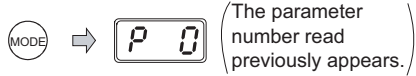

3. Turn the ⌚ until Pr. 39 "frequency setting current gain frequency" appears.
 - Pr. 30 must be set to "1"
 - (Refer to steps 3 to 6 on page 51 for the parameter setting method.)

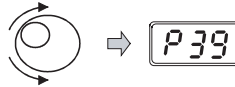

4. Press the SET to display the currently set value. (60Hz)



5. Turn the ⌚ to change it to "50.0". (50Hz)

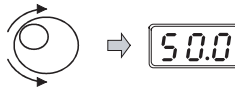

6. Press the SET to set the value.

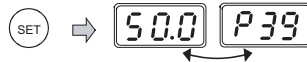

Flicker...Parameter setting complete!!

- By turning the ⌚ , you can read another parameter.
- Press the SET to show the setting again.
- Press the SET twice to show the next parameter.

? The monitor/frequency setting indication cannot be changed to just 50Hz ...Why?

👉 The calibration parameter C7 "frequency setting current gain" value must be set. (Refer to page 45.)

REMARKS

To change the value to more than 60Hz, Pr. 1 "maximum frequency" must be set to more than 60Hz.





Changing example Changing the calibration parameter C4 "frequency setting voltage gain"

POINT



The calibration parameter C4 is an extended function parameter. Pr. 30 must be set to "1".

- (2) Adjusting a deviation of the highest frequency from the Pr. 38 (Pr. 39) setting.
 (2-1) Making adjustment with a voltage applied directly across terminals 2-5 (with a current flowing across terminals 4-5)

Operation

1. Confirm the RUN indication and operation mode indication.
 - The inverter must be at a stop.
 - The inverter must be in PU operation mode.
 (Press the )
2. Press the  to choose the parameter setting mode.
3. Turn the  until "E . ." appears.
 - Pr. 30 must be set to "1".
 - (For details, refer to steps 3 to 6 on page 51.)
4. Press the  to show "E -".

When adjusting Pr. 38







5. Turn the  until the calibration parameter C4 "frequency setting voltage gain" appears.
6. Press the  to show the analog voltage value (%).
7. Apply a 5V voltage. (Turn the external potentiometer connected to across terminals 2-5 to the maximum (any position).)



Display



(The parameter number read previously appears.)

(Analog voltage value (%) across terminals 2-5)



*The value is nearly 100 (%) in the maximum position of the potentiometer.



CAUTION
 After performing operation in step 7, do not touch the  until completion of calibration.

8. Press the  to set the value.
 

Flicker ... Parameter setting complete!! (Adjustment complete)

*The value is nearly 100 (%) in the maximum position of the potentiometer.

- By turning the , you can read another parameter.
- Press the  to return to the "E -" indication (step 4).
- Press the  twice to show the next parameter (E L r).

- ? The frequency meter (indicator) connected to across terminals FM-SD does not indicate just 50Hz ... Why?
 The calibration parameter C1 "FM terminal calibration" value must be set. (Refer to page 46.)
- ? When write is performed, an error (E r 3) is displayed.
 The gain and bias frequency settings are too close.

5.2 Adjustment (calibration) of the frequency meter (indicator)

Changing example Deflecting the meter (analog indicator) to full-scale (1mA) at the preset frequency of 60Hz.
(Refer to page 24 for frequency setting.)

POINT

- The calibration parameters "C1" can be made to be read by setting "1" (extended function parameter valid) in Pr. 30 "extended function display selection".
- Set the value of the calibration parameter C1 "FM terminal calibration".

Operation

1. Press the **MODE** to choose the parameter setting mode.
2. Turn the **○** to show "C . ." setting.
 - Pr. 30 must be set to "1".
(For details, refer to steps 3 to 6 on page 51.)
3. Press the **SET** to show "C -".
4. Turn the **○** until the calibration parameter C1 "FM terminal calibration" appears.
5. Press the **SET** to enable setting.
6. If the inverter is at a stop, press the **RUN** to start the inverter.
(A motor need not be connected.)
7. Turn the **○** to adjust the indicator needle to the desired position.
8. Press the **SET**.
Setting is complete.

Display

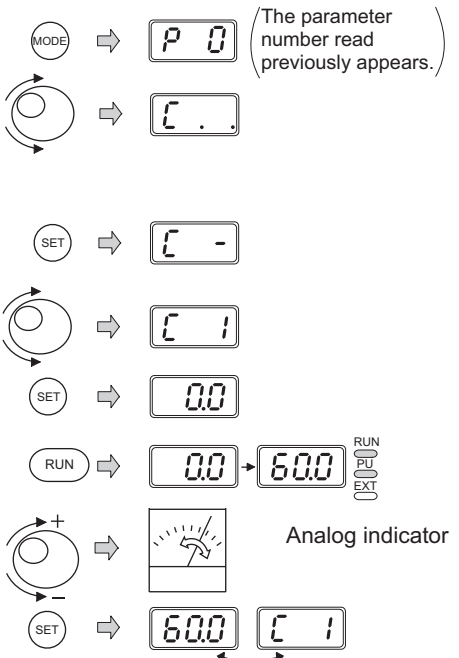

Flicker...Parameter setting complete!!

- By turning the **○**, you can read another parameter.
- Press the **SET** to return to the "C -" indication (step 3).
- Press the **SET** twice to show the next parameter (C L r).

REMARKS

- Depending on the set value, it may take some time for the needle to move.
- If "1" is set in Pr. 30 "extended function display selection", the calibration parameter C1 "FM terminal calibration" can also be set in external operation mode.

POINT

By setting the Pr. 54 "FM terminal function selection" value, preset Pr. 55 "frequency monitoring reference" or Pr. 56 "current monitoring reference" to the running frequency or current value at which the output signal is 1440 pulses/s. At 1440 pulses/s, the meter generally deflects to full-scale.

6. FUNCTION LIST

6.1 Basic function parameter list

Parameter	Name	Indication	Setting Range	Minimum Setting Increments	Factory Setting	Customer Setting
0	Torque boost	P 0	0 to 15%	0.1%	6%/5%/4% *	
1	Maximum frequency	P 1	0 to 120Hz	0.1Hz	60Hz	
2	Minimum frequency	P 2	0 to 120Hz	0.1Hz	0Hz	
3	Base frequency	P 3	0 to 120Hz	0.1Hz	60Hz	
4	Multi-speed setting (high speed)	P 4	0 to 120Hz	0.1Hz	60Hz	
5	Multi-speed setting (middle speed)	P 5	0 to 120Hz	0.1Hz	30Hz	
6	Multi-speed setting (low speed)	P 6	0 to 120Hz	0.1Hz	10Hz	
7	Acceleration time	P 7	0 to 999s	0.1s	5s	
8	Deceleration time	P 8	0 to 999s	0.1s	5s	
9	Electronic thermal O/L relay	P 9	0 to 50A	0.1A	Inverter rated current	
30	Extended function display selection	P 30	0, 1	1	0	
79	Operation mode selection	P 79	0 to 4, 7, 8	1	0	

* The factory setting varies with the inverter capacity: 5% for FR-S540E-1.5K and 2.2K, 4% for FR-S540E-3.7K.

REMARKS

- Setting "1" in Pr. 30 "extended function display selection" makes the extended function parameters valid. (Refer to page 51.)
- The decimal places of a value of 100 or more (3 digits or more) cannot be set to be displayed.

6.2 Explanation of the basic function parameters

For details, refer to the separately available instruction manual (detailed).

Pr. 0 "torque boost"

- Allows the motor torque in the low speed range to be adjusted according to the load. Make adjustment when stall prevention is operated when starting.
- When a constant-torque motor is used, set the following value:

	0.1K to 0.75K	1.5K	2.2K	3.7K
200V class	6%	4%	4%	
100V class		(6%)	(6%)	
400V class	6%	4%	3%	3%
		(5%)	(5%)	(4%)

Values in parenthesis are factory-set

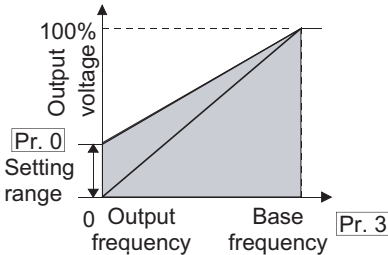

Pr. 1 "maximum frequency", Pr. 2 "minimum frequency"

- Clamp the upper and lower limits of the output frequency.

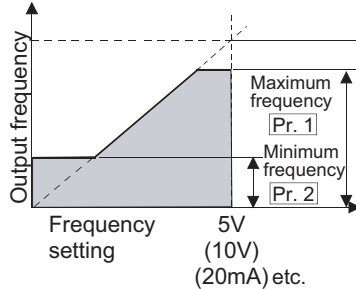

CAUTION

- A too large setting may cause the motor to overheat or result in an overcurrent trip. The guideline is about 10% at the greatest.

Pr. 3 "base frequency"

- Set the base frequency (reference frequency at rated motor torque) within the range 0 to 120Hz according to the motor.
- Check the motor rating plate. If a frequency given on the rating plate is "50Hz" only, always set Pr. 3 "base frequency" to "50Hz". Leaving the base frequency unchanged from "60Hz" may make the voltage low and the torque insufficient. It may result in an inverter trip (E.OC□) due to overload. If the frequency given on the rating plate is both "50Hz/60Hz", always set Pr. 3 "base frequency" to "60Hz".

Pr. 4 "multi-speed setting (high speed)" Pr. 5 "multi-speed setting (middle speed)" Pr. 6 "multi-speed setting (low speed)"

- You can select any speed (RH, RM, RL) by simply switching the external contact signal.

	RH	RM	RL
high-speed	ON	OFF	OFF
middle speed	OFF	ON	OFF
low speed	OFF	OFF	ON

- Each speed (frequency) can be set to any value within the range 0 to 120Hz if the inverter is running.
- The extended functions enable setting of up to 15 speeds.

**Pr. 7 "acceleration time",
Pr. 8 "deceleration time"**

- As the acceleration time, set the time taken to reach the acceleration/deceleration reference frequency in Pr. 20 from 0Hz (factory set to 60Hz), and as the deceleration time, set the time taken to reach 0Hz from the Pr. 20 value (factory set to 60Hz).

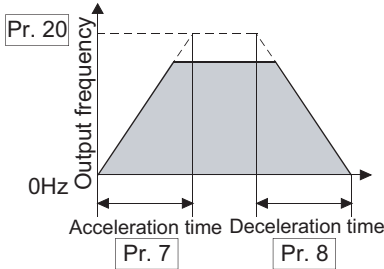

Pr. 9 "electronic thermal O/L relay"

- You can set a current value for protection of the motor from overheat. Normally, set the rated motor current at 50Hz as it is.
- At the setting of 0A, motor protection does not function. (The output transistor protection of the inverter functions.)
- When connecting multiple motors to the inverter, provide external thermal relays to individual motors.
- For the 0.75K or less, this value is factory-set to 85% of the rated inverter current.
- Turn the RT signal on to select the second electronic thermal relay function. (Refer to page 61.)





Pr. 30 "extended function display selection"

- Set this parameter when showing/setting the extended function parameters.

Setting	Definition
0	Only basic functions are displayed.
1	All parameters are displayed.

Pr. 79 "operation mode selection"













- The inverter has two different operation modes: operation under control of external signals and operation from the PU (setting dial, ) . You can use either or both operation modes.



Setting	Definition	
0	PU (setting dial, ) operation or external operation can be selected by the  .	
1	PU (setting dial, ) operation may be performed.	
2	Only external operation may be performed.	
3	Running frequency	Start signal
	<ul style="list-style-type: none"> Setting made by the setting dial Multi-speed selection 4 to 20mA (Made valid when the AU signal turns on) 	External terminal (STF/STR)
4	Running frequency	Start signal
	External terminal signals (multi-speed, 0 to 5VDC, etc.)	
7	PU operation interlock (Switching to the PU operation mode is enabled/disabled by turning the MRS signal ON/OFF)	
8	Operation mode external signal switching (disabled during operation) Turn the X16 signal ON/OFF to choose operation mode.	

6.3 Setting the parameters

6.3.1 Example: Changing the Pr. 7 setting from "5s" to "10s"

(For parameter details, refer to the instruction manual (detailed).)



Operation	Display
<p>1. Confirm the RUN indication and operation mode indication.</p> <ul style="list-style-type: none"> ● The inverter must be at a stop. ● The inverter must be in PU operation mode. (Press the .) <p>2. Press the  to choose the parameter setting mode.</p> <p>3. Turn the  until the desired parameter number appears. Example: Pr. 7 "acceleration time"</p> <p>4. Press the  to read the currently set value. Example: "5" (factory setting) appears.</p> <p>5. Turn the  until the desired value appears. Example: To change setting from "5" to "10".</p> <p>6. Press the  to set the value.</p>	  (The parameter number read previously appears.)     <p style="text-align: center;">Flicker ... Parameter setting complete!!</p>

- By turning the , you can read another parameter.
- Press the  to show the setting again.
- Press the  twice to show the next parameter.

After parameter setting is complete, press the  once to show the alarm history or twice to return to the monitor display.

To change the setting of another parameter, perform the operation in above steps 3 to 6.

? Error display?

-  Er 1
 - If write was performed with "1" set in Pr. 77
 - If the operation panel does not have the write precedence
-  Er 2
 - If write was performed during operation
 - If write was performed in the external operation mode



















REMARKS

- If the setting has not been changed, the value does not flicker and the next parameter number appears.
- Either step 1 or 2 may be carried out first.
- Convenient usage



After carrying out steps 1 and 2 to choose the parameter setting mode, you can read a series of parameter numbers in due order every time you press the .

6.4 Display the extended function parameter

(The extended parameters are made valid by setting "1" in Pr. 30 "extended function display selection".)

Operation	Display
<p>1. Confirm the RUN indication and operation mode indication.</p> <ul style="list-style-type: none"> ● The inverter must be at a stop. ● The inverter must be in PU operation mode. (Press the ) 	
<p>2. Press the  to choose the parameter setting mode.</p>	<p> →  (The parameter number read previously appears.)</p>
<p>3. Turn the  until P 30 (Pr. 30) appears.</p>	<p> → </p>
<p>4. Press the  to read the currently set value. " 0 " (factory setting) appears.</p>	<p> → </p>
<p>5. Turn the  to change it to the set value of "1".</p>	<p> → </p>
<p>6. Press the  to set the value.</p>	<p> →  → </p>



Flicker ... Parameter setting complete!!

- By turning the , you can read another parameter.
- Press the  to show the setting again.
- Press the  twice to show the next parameter.

After parameter setting is complete, press the  once to show the alarm history or twice to return to the monitor display.

To change the setting of another parameter, perform the operation in above steps 3 to 6.

? Error display?

-  Er 1 • If the operation panel does not have the write precedence
-  Er 2 • If write was performed during operation.
- If write was performed in the external operation mode

REMARKS

If the setting has not been changed, the value does not flicker and the next parameter number appears.

6.5 Extended function parameter list

Setting "1" in Pr. 30 "extended function display selection" makes the extended function parameters valid. (Refer to the separately available instruction manual (detailed).)

Parameter	Indication	Name	Description	Factory Setting
For parameters 0 to 9, refer to the basic function parameters. (page 47.)				
10	P 10	DC injection brake operation frequency	Set the timing of switching to DC injection brake (0 to 120Hz), the time to apply DC injection brake (0 to 10s), and the braking torque at DC injection brake start (0 to 15%). (Set Pr. 12 to 4% when a constant-torque motor is used.)	3Hz
11	P 11	DC injection brake operation time		0.5s
12	P 12	DC injection brake voltage		6%
13	P 13	Starting frequency	Frequency which is output by the inverter first at a start and gives great influence to the starting torque. About 1 to 3Hz for vertical lift applications, or up to 5Hz to the maximum. For other than vertical lift applications, factory setting of about 0.5Hz is recommended. 0 to 60Hz	0.5Hz
14	P 14	Load pattern selection	Choose the output frequency and output voltage patterns according to the application (load characteristic). 0: For constant-torque loads (when relatively large torque is needed at low to high speeds) 1: For variable-torque loads (for applications where torque is small at low speed, e.g. fans and pumps) 2: For vertical lifts (for elevators at reverse rotation boost of 0%) 3: For vertical lifts (for elevators at forward rotation boost of 0%)	0
15	P 15	Jog frequency	Speed command (0 to 120Hz) and acceleration/deceleration slope (0 to 999s) for jog (inching) operation When the FR-PU04 is connected, these parameters can be read as the basic parameters.	5Hz
16	P 16	Jog acceleration/ deceleration time		0.5s
17	P 17	RUN key rotation direction selection	The  of the operation panel can be used to choose the direction of rotation for operation. 0: Forward rotation, 1: Reverse rotation	0

Parameter		Name	Description	Factory Setting																				
Indication																								
19	P19	Base frequency voltage	Indicates the magnitude of the output voltage at the base frequency (Pr.3) 888: 95% of power supply voltage (1.9 times greater than the power supply voltage for the 100V class) ---: Same as power supply voltage (Twice greater than the power supply voltage for the 100V class) 0 to 800V, 888, ---	---																				
20	P20	Acceleration/ deceleration base frequency	Indicates the frequency to be referenced for acceleration from or deceleration to 0Hz in the time set in Pr. 7 "acceleration time" or Pr. 8 "deceleration time". 1 to 120Hz	60Hz																				
21	P21	Stall prevention function selection	Stall prevention is a function designed to suspend a frequency increase during acceleration, decrease frequency during constant speed or suspend a frequency decrease during deceleration if the preset current (0 to 200%) is exceeded, in order to prevent an overcurrent alarm. Pr. 21 allows you to select whether to use stall prevention or not according to the acceleration/deceleration status. Since the fast response current limit value is 170%, torque will not be developed if Pr. 22 is set to more than 170%. In that case, set "1" in Pr. 21.	0																				
22	P22	Stall prevention operation level		150%																				
23	P23	Stall prevention operation level compensation factor at double speed	Used to reduce the stall prevention level at or above the base frequency. Setting other than "---" specifies the current level at 120Hz which is lower than the Pr. 22 value of the stall prevention level at base frequency. 0 to 200%, ---	---																				
24	P24	Multi-speed setting (speed4)	Setting other than "---" specifies speeds 4 to 7. By combining ON and OFF of the contact signals (RH, RM, RL signals), the running speed can be changed step-by-step.	---																				
25	P25	Multi-speed setting (speed 5)		---																				
26	P26	Multi-speed setting (speed 6)		---																				
27	P27	Multi-speed setting (speed 7)		---																				
			<table border="1"> <tr> <td></td> <td>RH</td> <td>RM</td> <td>RL</td> </tr> <tr> <td>Speed 4</td> <td>OFF</td> <td>ON</td> <td>ON</td> </tr> <tr> <td>Speed 5</td> <td>ON</td> <td>OFF</td> <td>ON</td> </tr> <tr> <td>Speed 6</td> <td>ON</td> <td>ON</td> <td>OFF</td> </tr> <tr> <td>Speed 7</td> <td>ON</td> <td>ON</td> <td>ON</td> </tr> </table>		RH	RM	RL	Speed 4	OFF	ON	ON	Speed 5	ON	OFF	ON	Speed 6	ON	ON	OFF	Speed 7	ON	ON	ON	
	RH	RM	RL																					
Speed 4	OFF	ON	ON																					
Speed 5	ON	OFF	ON																					
Speed 6	ON	ON	OFF																					
Speed 7	ON	ON	ON																					
28	P28	Stall prevention operation reduction starting frequency	0 to 120Hz, ---	60Hz																				

Parameter		Name	Description	Factory Setting
Indication				
29	P39	Acceleration/ deceleration pattern	Determines the frequency changing pattern for acceleration/deceleration. 0: Linear acceleration/deceleration 1: S-pattern acceleration/deceleration A (e.g. machine tool spindle applications) 2: S-pattern acceleration/deceleration B (for prevention of load shifting in conveyor and other applications.)	0
31	P31	Frequency jump 1A	Set the frequency range you want to evade during constant-speed operation to avoid resonance with a machine. 0 to 120Hz, - - -	- - -
32	P32	Frequency jump 1B		- - -
33	P33	Frequency jump 2A		- - -
34	P34	Frequency jump 2B		- - -
35	P35	Frequency jump 3A		- - -
36	P36	Frequency jump 3B		- - -
37	P37	Speed display		You can convert the frequency monitor/set frequency of the operation panel into the load speed and display it. Setting 0 shows the output frequency, and setting 0.1 to 999 shows the load speed. (Set the speed for 60Hz operation.) 0, 0.1 to 999
38	P38	Frequency setting voltage gain frequency	You can set as desired the magnitude (slope) of the output frequency to the external frequency setting voltage signal (0 to 5V or 0 to 10V). 1 to 120Hz	60Hz
39	P39	Frequency setting current gain frequency	You can set as desired the magnitude (slope) of the output frequency to the external frequency setting current signal (4 to 20mA). 1 to 120Hz	60Hz
40	P40	Start-time earth (ground) fault detection selection	Set whether an earth (ground) fault is to be detected or not at a start. 0: Not detected 1: Detected	0
41	P41	Up-to-frequency	You can adjust the ON range of the up-to-frequency signal (SU) to be output when the output frequency reaches the running frequency. You can use this function to ensure that the running frequency has been reached or use it as the operation start signal etc. for related equipment. Use Pr. 64 or Pr. 65 to assign the terminal used for SU signal output. 0 to 100%	10%

Parameter	Indication	Name	Description	Factory Setting
42	P42	Output frequency detection	Set the reference value at which the signal (FU) is output when the output frequency rises to or above a certain value. This function can be used for electromagnetic brake operation, open signal, etc. Use Pr. 64 or Pr. 65 to assign the terminal used for the FU signal. 0 to 120Hz	6Hz
43	P43	Output frequency detection for reverse operation	Set the reference value at which the signal (FU) is output when the output frequency rises to or above a certain value. This function is valid for reverse operation. 0 to 120Hz, - - -	- - -
44	P44	Second acceleration/ deceleration time	Second function of the acceleration/ deceleration time set in Pr. 7, Pr. 8. 0 to 999s	5s
45	P45	Second deceleration time	Second function for the deceleration time set in Pr. 8. 0 to 999s, - - -	- - -
46	P46	Second torque boost	Second function for the torque boost set in Pr. 0. 0 to 15%, - - -	- - -
47	P47	Second V/F (base frequency)	Second function for the base frequency set in Pr. 3 0 to 120Hz, - - -	- - -
48	P48	Output current detection level	Set the level at which the output current detection signal (Y12) is output. 0 to 200%	150%
49	P49	Output current detection signal delay time	When the output current is at or above the output current detection level (Pr. 48) for longer than this period (Pr. 49), the output current detection signal (Y12) is output. 0 to 10s	0s
50	P50	Zero current detection level	Set the level at which the zero current detection signal (Y13) is output. 0 to 200%	5%
51	P51	Zero current detection period	When the output current is at or below the zero current detection level (Pr. 50) for longer than this period (Pr. 51), the zero current detection signal (Y13) is output. 0.05 to 1s	0.5s

Extended function parameter list

Parameter		Name	Description	Factory Setting
Indication				
52	P52	Operation panel display data selection	You can choose the data displayed on the operation panel. 0: Output frequency 1: Output current 100: Set frequency during stop/output frequency during operation	0
53	P53	Frequency setting operation selection	You can use the setting dial like a potentiometer to perform operation. 0: Setting dial frequency setting mode 1: Setting dial potentiometer mode	0
54	P54	FM terminal function selection	You can choose the indicator connected to the FM terminal. 0: Output frequency monitor 1: Output current monitor	0
55	P55	Frequency monitoring reference	Set the reference value of frequency monitoring. 0 to 120Hz	60Hz
56	P56	Current monitoring reference	Set the reference value of current monitoring. 0 to 50A	Rated inverter current
57	P57	Restart coasting time	At power restoration after an instantaneous power failure, you can restart the inverter without motor being stopped (with the motor coasting). The inverter begins to restart after this period (Pr. 57) has elapsed after power restoration. When you set "--", a restart is not made.	---
58	P58	Restart cushion time	"0" setting generally does not pose a problem but you can adjust the time (0 to 5s, ---) according to the magnitude of the load. When the restart coasting time (Pr. 57) has elapsed, the output voltage is risen gradually. Set this cushion time (Pr. 58) (0 to 60s). Operation may be performed generally at the factory setting, but you can adjust the time according to the magnitude of the load. Refer to additional parameter H6 for selection of speed search. (Refer to page 61.)	1s
59	P59	Remote setting function selection	You can set the remote setting function which is used when the operation panel is away from the enclosure, for example. 0: Without remote setting function 1: With remote setting function With frequency setting storage function 2: With remote setting function Without frequency setting storage function	0

Parameter		Name	Description	Factory Setting
Indication				
60	P60	RL terminal function selection	You can select the following input signals. 0: RL (multiple low-speed run command) 1: RM (multiple middle-speed run command) 2: RH (multiple high-speed run command) 3: RT (second function selection) 4: AU (current input selection) 5: STOP (start self-holding selection) 6: MRS (output stop)	0
61	P61	RM terminal function selection	7: OH (external thermal relay input) 8: REX (15 multi-speed selection) 9: JOG (jog operation selection) 10: RES (reset)	1
62	P62	RH terminal function selection	14: X14 (PID control valid terminal) 16: X16 (PU operation/external operation switching) ---: STR (reverse rotation start (may be assigned to only STR terminal))	2
63	P63	STR terminal function selection	14: X14 (PID control valid terminal) 16: X16 (PU operation/external operation switching) ---: STR (reverse rotation start (may be assigned to only STR terminal))	---
64	P64	RUN terminal function selection	You can select the following input signals. 0: RUN (inverter running) 1: SU (up-to-frequency) 3: OL (overload warning) 4: FU (output frequency detection) 11: RY (operation ready)	0
65	P65	A, B, C terminal function selection	12: Y12 (output current detection) 13: Y13 (zero current detection) 14: FDN (PID lower limit signal) 15: FUP (PID upper limit signal) 16: RL (PID forward/reverse rotation signal) 93: Y93 (current average value monitor signal (can be assigned to the RUN terminal only)) 95: Y95 (maintenance timer alarm) 98: LF (minor failure output) 99: ABC (alarm output)	99
66	P66	Retry selection	You can choose the retry alarm to be activated when the protective function is activated. 0: OC1 to 3, OV1 to 3, THM, THT, BE, GF, OHT, OLT, PE, OPT 1: OC1 to 3, 2: OV1 to 3, 3: OC1 to 3, OV1 to 3	0
67	P67	Number of retries at alarm occurrence	You can set the number of retries to be made when the protective function is activated. 0: No retry 1 to 10: Without alarm output during retry operation 101 to 110: With alarm output during retry operation	0

Parameter	Indication	Name	Description	Factory Setting															
68	P68	Retry waiting time	You can set the waiting time from when the protective function is activated until a retry is made. 0.1 to 360s	1s															
69	P69	Retry count display erase	You can display the cumulative number of successful restarts made by retries when the protective function is activated. 0: Cumulative count erase	0															
70	P70	Soft-PWM setting	<p>You can select whether to exercise Soft-PWM control and long wiring mode. When Soft-PWM is valid, you can change the metallic motor tone into an unoffending complex tone. Surge voltage is suppressed regardless of wiring length if the long wiring mode is set for the 400V class.</p> <table border="1"> <thead> <tr> <th></th> <th>Soft-PWM</th> <th>Long Wiring Mode</th> </tr> </thead> <tbody> <tr> <td>0</td> <td>without</td> <td>without</td> </tr> <tr> <td>1</td> <td>with</td> <td>without</td> </tr> <tr> <td>10</td> <td>without</td> <td>with</td> </tr> <tr> <td>11</td> <td>with</td> <td>with</td> </tr> </tbody> </table> <p>When Pr. 72 "PWM frequency selection" = 1 or more, the PWM carrier frequency is constant at 1kHz. (When "0" is set, the PWM carrier frequency is constant at 0.7kHz.)</p>		Soft-PWM	Long Wiring Mode	0	without	without	1	with	without	10	without	with	11	with	with	1
	Soft-PWM	Long Wiring Mode																	
0	without	without																	
1	with	without																	
10	without	with																	
11	with	with																	
71	P71	Applied motor	<p>Set the motor to be used.</p> <p>0, 100: Thermal characteristic for Mitsubishi standard motor 1, 101: Thermal characteristic for Mitsubishi constant-torque motor</p> <p>When "100 or 101" is set, turning on the RT signal set the electronic thermal relay function to the thermal characteristic for the constant-torque motor.</p>	0															
72	P72	PWM frequency selection	<p>You can change the PWM carrier frequency. Increasing this value reduces the motor audible noise, but increases noise and leakage current. The setting is in [kHz]. 0: 0.7kHz, 15: 14.5kHz 0 to 15 (Remarks) Metallic sound may be generated from the motor at sudden deceleration but it is not a fault.</p>	1															
73	P73	0-5V/0-10V selection	<p>You can set the input voltage specification of terminal "2". 0: For 0 to 5VDC input 1: For 0 to 10VDC input</p>	0															
74	P74	Input filter time constant	<p>Valid for eliminating noise of the frequency setting circuit. A larger set value increases the time constant. 0 to 8</p>	1															

Parameter	Indication	Name	Description	Factory Setting																																													
75	P75	Reset selection/PU stop selection	You can choose the function of the  on the operation panel.	14																																													
					<table border="1"> <thead> <tr> <th></th> <th>Reset Input</th> <th>PU Stop Key Input</th> </tr> </thead> <tbody> <tr> <td>0</td> <td>Normally enabled</td> <td rowspan="2">Invalid (Valid only in the PU operation mode or combined operation mode (Pr. 79=4))</td> </tr> <tr> <td>1</td> <td>Reset input is enabled only when the protective function is activated</td> </tr> <tr> <td>14</td> <td>Normally enabled</td> <td rowspan="2">Valid</td> </tr> <tr> <td>15</td> <td>Reset input is enabled only when the protective function is activated</td> </tr> </tbody> </table>		Reset Input	PU Stop Key Input	0	Normally enabled	Invalid (Valid only in the PU operation mode or combined operation mode (Pr. 79=4))	1	Reset input is enabled only when the protective function is activated	14	Normally enabled	Valid	15	Reset input is enabled only when the protective function is activated																															
					Reset Input	PU Stop Key Input																																											
			0		Normally enabled	Invalid (Valid only in the PU operation mode or combined operation mode (Pr. 79=4))																																											
			1		Reset input is enabled only when the protective function is activated																																												
14	Normally enabled	Valid																																															
15	Reset input is enabled only when the protective function is activated																																																
76	P76	Cooling fan operation selection	<p>You can control the operation of the cooling fan built in the inverter. (Operates in power-on status.)</p> <p>0: The fan normally operates at power on of the inverter.</p> <p>1: The fan is normally on during inverter operation. The fan switches on/off according to the temperature during a stop of the inverter whose status is monitored.</p>	1																																													
77	P77	Parameter write disable selection	<p>You can choose whether to enable or disable parameter write.</p> <p>0: Write is enabled only during a stop in PU operation mode</p> <p>1: Write disabled (except some parameters)</p> <p>2: Write during operation enabled (external mode and during operation)</p>	0																																													
78	P78	Reverse rotation prevention selection	<p>You can prevent trouble during reverse operation due to false input of the start signal.</p> <p>0: Both forward rotation and reverse rotation enabled</p> <p>1: Reverse rotation disabled</p> <p>2: Forward rotation disabled</p>	0																																													
For parameter 79, refer to the basic function parameters. (page 47.)																																																	
80	P80	Multi-speed setting (speed 8)	<p>Setting other than " - - - " specifies speeds 8 to 15.</p> <p>By combining ON and OFF of the contact signals (RH, RM, RL, REX signals), the running speed can be changed step-by-step.</p> <p>Use Pr. 63 to assign the REX signal.</p> <table border="1"> <thead> <tr> <th></th> <th>RH</th> <th>RM</th> <th>RL</th> <th>REX</th> </tr> </thead> <tbody> <tr> <td>Speed 8</td> <td>OFF</td> <td>OFF</td> <td>OFF</td> <td>ON</td> </tr> <tr> <td>Speed 9</td> <td>OFF</td> <td>OFF</td> <td>ON</td> <td>ON</td> </tr> <tr> <td>Speed 10</td> <td>OFF</td> <td>ON</td> <td>OFF</td> <td>ON</td> </tr> <tr> <td>Speed 11</td> <td>OFF</td> <td>ON</td> <td>ON</td> <td>ON</td> </tr> <tr> <td>Speed 12</td> <td>ON</td> <td>OFF</td> <td>OFF</td> <td>ON</td> </tr> <tr> <td>Speed 13</td> <td>ON</td> <td>OFF</td> <td>ON</td> <td>ON</td> </tr> <tr> <td>Speed 14</td> <td>ON</td> <td>ON</td> <td>OFF</td> <td>ON</td> </tr> <tr> <td>Speed 15</td> <td>ON</td> <td>ON</td> <td>ON</td> <td>ON</td> </tr> </tbody> </table>		RH	RM	RL	REX	Speed 8	OFF	OFF	OFF	ON	Speed 9	OFF	OFF	ON	ON	Speed 10	OFF	ON	OFF	ON	Speed 11	OFF	ON	ON	ON	Speed 12	ON	OFF	OFF	ON	Speed 13	ON	OFF	ON	ON	Speed 14	ON	ON	OFF	ON	Speed 15	ON	ON	ON	ON	---
	RH	RM		RL	REX																																												
Speed 8	OFF	OFF		OFF	ON																																												
Speed 9	OFF	OFF		ON	ON																																												
Speed 10	OFF	ON		OFF	ON																																												
Speed 11	OFF	ON		ON	ON																																												
Speed 12	ON	OFF		OFF	ON																																												
Speed 13	ON	OFF		ON	ON																																												
Speed 14	ON	ON	OFF	ON																																													
Speed 15	ON	ON	ON	ON																																													
81	P81	Multi-speed setting (speed 9)	---																																														
82	P82	Multi-speed setting (speed 10)	---																																														
83	P83	Multi-speed setting (speed 11)	---																																														
84	P84	Multi-speed setting (speed 12)	---																																														
85	P85	Multi-speed setting (speed 13)	---																																														
86	P86	Multi-speed setting (speed 14)	---																																														
87	P87	Multi-speed setting (speed 15)	0 to 120Hz, - - -	---																																													

Extended function parameter list

Parameter		Name	Description	Factory Setting
Indication				
88	<i>P88</i>	PID action selection	Used to choose the operation of PID control. 20: PID reverse action, 21: PID forward action	20
89	<i>P89</i>	PID proportional band	Used to set the proportional band for PID control. 0.1 to 999%, - - -	100%
90	<i>P90</i>	PID integral time	Used to set the integral time for PID control. 0.1 to 999s, - - -	1s
91	<i>P91</i>	PID upper limit	Used to set the upper limit value for PID control. 0 to 100%, - - -	- - -
92	<i>P92</i>	PID lower limit	Used to set the lower limit value for PID control. 0 to 100%, - - -	- - -
93	<i>P93</i>	PID action set point for PU operation	Used to set the PID action set point for PU operation. 0 to 100%	0%
94	<i>P94</i>	PID differential time	Used to set the differential time for PID control. 0.01 to 10s, - - -	- - -
95	<i>P95</i>	Rated motor slip	Used to set the rated motor slip to make slip compensation. 0 to 50%, - - -	- - -
96	<i>P96</i>	Slip compensation time constant	Used to set the response time of slip compensation. 0.01 to 10s	0.5s
97	<i>P97</i>	Constant-power range slip compensation selection	Used to choose whether slip compensation is made or not in the constant-power range. 0, - - -	- - -
98	<i>P98</i>	Automatic torque boost selection (Motor capacity)	You can set the motor capacity and exercise automatic torque boost control. When you set "- - -", V/F control is exercised. Set the motor capacity used. <ul style="list-style-type: none"> •The motor capacity should be equal to or one rank lower than the inverter capacity. •The number of motor poles should be 2, 4 or 6. (Only 4 poles for constant-torque motor) •Single-motor operation (one motor run by one inverter) should be performed. •Wiring length from inverter to motor should be within 30m. When using a constant-torque motor, set "1" in Pr. 71. <Example> For 1.5kW, set "1.5". 0.1 to 3.7kW, - - -	- - -
99	<i>P99</i>	Motor primary resistance	You can set the motor's primary resistance value. (Normally, this parameter need not be set.) 0 to 50Ω, - - -	- - -

●Maintenance parameters

Parameter		Name	Description	Factory Setting
	Indication			
H1	H 1	Maintenance timer	Display the maintenance timer (cumulative energization time) in 1000h increments. Parameter write is not enabled. 0 to 999	0
	(503)			
H2	H 2	Maintenance timer alarm output set time	When the maintenance timer has elapsed the time set in H2, the Y95 signal is output. Assign the Y95 signal with Pr. 64 or Pr. 65. 0 to 999, ---	36 (36000h)
	(504)			
H3	H 3	Current average time	The average value of the output current during constant speed operation and the maintenance timer value are output to the current average value monitor signal (Y93). Y93 signal is output for 20s as 1 cycle in order of start pulse for 1s (Hi), output current average value for 0.5 to 9s (Low), maintenance timer value for 2 to 9s (Hi), and end signal (Low). Assign the Y93 signal to the RUN terminal using Pr. 64.	1s
	(555)			
H4	H 4	Data output mask time	Set the time (0.1 to 1s) taken to calculate average value of the output current during constant operation in H3. Set the time (0 to 20s) for not outputting the Y93 signal to invalidate retrieving of output current value in the transient state right after the speed is changed from acceleration/deceleration to constant speed in H4.	0s
	(556)			
H5	H 5	Current average value monitor signal output reference current	Set the current value (0.1 to 999A) when outputting the average value of output current as a low pulse shape for 5s in H5.	1A
	(557)			

●Additional parameters

Parameter		Name	Description	Factory Setting
	Indication			
H6	H 6	Automatic restart after instantaneous power failure selection	You can select whether to use system to detect the motor speed (speed search system) at the time of restart after instantaneous power failure or not 0: with speed search, 1: without speed search, 10: with speed search at starting	1
	(162)			
H7	H 7	Second electronic thermal O/L relay	Protect the second motor from overheat. Set the rated current value of the second motor. Made valid when the RT signal turns on. Refer to Pr. 9 for its function. 0 to 50A, ---	---
	(559)			

● Brake parameters

Set when using the brake resistor.

(These parameters can be read on only the FR-S520E-0.4K to 3.7K.)

Parameter		Name	Description	Factory Setting
	Indication			
b1	<i>b 1</i>	Regenerative function selection	Set when using the optional dedicated brake resistor. 0: Brake resistor (MRS/MYS type), brake unit (BU type) (1.5K or more) 1: High-duty brake resistor (FR-ABR)	0
	(560)			
b2	<i>b 2</i>	Special regenerative brake duty	Set when using the optional high-duty brake resistor (FR-ABR). Setting can be made when b1=1. Set 10% in Pr. 561 when using the FR-ABR. 0 to 30%	0%
	(561)			

● Calibration parameter

Parameter		Name	Description	Factory Setting
	Indication			
C1	$\text{E } 1$	FM terminal calibration	You can calibrate the indicator connected to across terminals FM-SD. —	—
	(900)			
C2	$\text{E } 2$	Frequency setting voltage bias frequency	You can set as desired the magnitude (slope) of the output frequency to the external frequency setting voltage signal (0 to 5V or 0 to 10V). (Bias frequency) 0 to 60Hz	0Hz
	(902)			
C3	$\text{E } 3$	Frequency setting voltage bias	Used to adjust the analog voltage value of the frequency set in calibration parameter C2. (Bias %) 0 to 300%	0%*
	(902)			
C4	$\text{E } 4$	Frequency setting voltage gain	Used to adjust the analog voltage value of the frequency set in Pr. 38. (Gain %) 0 to 300%	96%*
	(903)			
C5	$\text{E } 5$	Frequency setting current bias frequency	You can set as desired the magnitude (slope) of the output frequency to the external frequency setting current signal (4 to 20mA). 0 to 60Hz	0Hz
	(904)			
C6	$\text{E } 6$	Frequency setting current bias	Used to adjust the analog current value of the frequency set in calibration parameter C5. (Bias %) 0 to 300%	20%*
	(904)			
C7	$\text{E } 7$	Frequency setting current gain	Used to adjust the analog current value of the frequency set in Pr. 39 (Gain %) 0 to 300%	100%*
	(905)			
C8	$\text{E } 8$	Parameter for manufacturer setting. Do not set.		
	(269)			
CLr	$\text{E } \text{CLr}$	Parameter clear	0: Not executed 1: Initialization of parameters other than calibration values (parameter clear) 10: Initialization of parameters including calibration values (all clear)	0
ECL	$\text{E } \text{ECL}$	Alarm history clear	0: Not cleared 1: Alarm history clear	0

*Settings may differ because of calibration parameters.

●Communication parameters

For details of the program, etc., refer to the instruction manual (detailed) separately available.

POINT

To make RS-485 communication between the inverter and personal computer, the operation mode must be set to the "computer link operation mode".
Pr. 79 "operation mode selection" ≠ "1, 3, 4"
and
communication parameter n10 "link startup mode selection" = "1"

Parameter	Indication	Name	Description	Factory Setting
n1	<i>n 1</i>	Communication station number*	Set the station number for communication from the RS-485 connector. 0 to 31: Specify the station number of the inverter.	0
(331)				
n2	<i>n 2</i>	Communication speed*	48: 4800bps 96: 9600bps 192: 19200bps	192
(332)				
n3	<i>n 3</i>	Stop bit length*	0: Stop bit length 1 bit/data length 8 1: Stop bit length 2 bits/data length 8 10: Stop bit length 1 bit/data length 7 11: Stop bit length 2 bits/data length 7	1
(333)				
n4	<i>n 4</i>	Parity check presence/absence*	0: Absent 1: With odd parity check 2: With even parity check	2
(334)				
n5	<i>n 5</i>	Number of communication retries	Set the permissible number of retries at occurrence of a data receive error. When you set "--", the inverter will not come to an alarm stop if a communication error occurs. 0 to 10, ---	1
(335)				
n6	<i>n 6</i>	Communication check time interval	Set the interval of communication check time. If a no-communication status persists for longer than the permissible time, the inverter will come to an alarm stop. 0: No communication 0.1 to 999s ---: Check suspended To make communication, set any value other than 0 in the communication parameter n6 "communication check time interval".	---
(336)				
n7	<i>n 7</i>	Waiting time setting*	Set the waiting time from when data is transmitted to the inverter until response is made. 0 to 150ms ---: Set in communication data	---
(337)				
n8	<i>n 8</i>	Run command source	You can choose whether the run command is given by the computer or the external terminal. 0: Command source is computer 1: Command source is external terminal	0
(338)				

Parameter	Indication	Name	Description	Factory Setting
(339)				
n10	<i>n 10</i>	Link startup mode selection	You can choose the operation mode at power on or at power restoration after instantaneous power failure. Set "1" to select the computer link operation mode. 0: Mode set in Pr. 79 is established. 1: Started in computer link mode.	0
(340)				
n11	<i>n 11</i>	CR/LF selection*	0: Without CR/LF 1: With CR, without LF 2: With CR/LF	1
(341)				
n12	<i>n 12</i>	E ² PROM write selection	0: Write to RAM and E ² PROM 1: Write to RAM only (When a reset is performed, the parameter value will be the value of E ² PROM.)	0
(342)				

* Perform a reset after setting parameter. The set values are reflected after a reset.

●Parameters for the PU

When the parameter unit (FR-PU04) is used, operation from the operation panel is not accepted. (STOP/RESET is valid)

Parameter	Indication	Name	Outline	Factory Setting
(145)				
n14	<i>n 14</i>	PU buzzer control	0: Without sound, 1: With sound	1
(990)				
n15	<i>n 15</i>	PU contrast adjustment	 0 (Light) 63(Dark)	58
(991)				
n16	<i>n 16</i>	PU main display screen data selection	0: Selectable between output frequency and output current 100:Set frequency (during stop) Output frequency (during operation)	0
(992)				
n17	<i>n 17</i>	Disconnected PU detection/PU setting lock	0: Without PU disconnection error/PU operation valid 1: Error at PU disconnection/PU operation valid 10: Without PU disconnection error/PU operation invalid	0
(993)				

REMARKS

- The parameter number in parentheses is the one for use with the parameter unit (FR-PU04).
- Set "9999" when setting a value "--" using the parameter unit (FR-PU04).
- Pr. stands for a parameter number.

7. ERRORS AND PROTECTIVE FUNCTIONS

7.1 About errors (definitions)

When an alarm occurs in the inverter, the protective function is activated bringing the inverter to an alarm stop and the PU display automatically changes to any of the following error (alarm) indications.

For details, refer to the separately available instruction manual (detailed).

(1) Major failures

Operation Panel Indication	Function Name	Definition
<i>OC 1</i> (OC1)	Overcurrent shut-off during acceleration	The inverter output current rose to or above about 200% of the rated inverter current during acceleration.
<i>OC 2</i> (OC2)	Overcurrent shut-off during constant speed	The inverter output current rose to or above about 200% of the rated inverter current during constant speed operation.
<i>OC 3</i> (OC3)	Overcurrent shut-off during deceleration	The inverter output current rose to or above about 200% of the rated inverter current during deceleration.
<i>OV 1</i> (OV1)	Regenerative overvoltage shut-off during acceleration	Excessive regenerative energy or surge voltage occurred during acceleration.
<i>OV 2</i> (OV2)	Regenerative overvoltage shut-off during constant speed	Excessive regenerative energy or surge voltage occurred during constant speed.
<i>OV 3</i> (OV3)	Regenerative overvoltage shut-off during deceleration or stop	Excessive regenerative energy or surge voltage occurred during deceleration or stop.
<i>THN</i> (THM)	Motor overload shut-off (Electronic thermal relay function) (*1)	Overload or reduced cooling capability during low-speed operation Protection against burnout due to motor temperature rise
<i>THF</i> (THT)	Inverter overload shut-off (Electronic thermal relay function) (*1)	Current more than 150% of the rated inverter current flew and overcurrent shut-off did not occur. Output transistor protection from overheat
<i>FIN</i> (FIN)	Fin overheat	Temperature rise of the heatsink.
<i>GF</i> (GF)	Start-time output side earth (ground) fault overcurrent (*2)	Earth (Ground) fault occurred on the inverter's output side at a start.

*1. Resetting the inverter initializes the internal thermal integration data of the electronic thermal relay function.

*2. Activated only when "1" is set in Pr. 40 "start-time earth (ground) fault detection selection".



Operation Panel Indication	Function Name	Definition
<i>OHT</i> (OHT)	External thermal relay (*3)	External thermal relay provided for protection from overheat was actuated (contact open).
<i>OLT</i> (OLT)	Stall prevention (overload)	Stall prevention was activated to drop the running frequency to 0. (OL appears while stall prevention is activated.)
<i>BE</i> (BE)	Brake transistor alarm	Error occurred in the brake circuit, e.g. damaged brake transistors. (can be connected to the FR-S520E-0.4K to 3.7K only)
<i>OPT</i> (OPT)	Communication error	<ul style="list-style-type: none"> • Communication errors occurred consecutively more than the permissible number of retries when the RS-485 connector is used and communication parameter n5 ≠ "- - -". • RS-485 communication error occurred. • Communication has broken for a period set in communication parameter n6.
<i>PE</i> (PE)	Parameter storage device alarm	Error occurred in the parameter stored.
<i>PUE</i> (PUE)	PU disconnected	PU was disconnected when communication parameter n17 = "1".
<i>RET</i> (RET)	Retry count over	Operation could not be resumed properly within the preset number of retries.
<i>CPU</i> (CPU)	CPU error	Arithmetic operation of the built-in CPU does not end within the predetermined time.

*3. Activated only when any of Pr. 60 to Pr. 63 (input terminal function selection) is set to OH.

(2) Minor failures

Operation Panel Indication	Function Name	Definition
<i>FN</i> (FN)	Fan trouble	The cooling fan built in the inverter failed (stopped).

(3) Warnings

Operation Panel Indication	Function Name	Definition
OL (OL)	Stall prevention (overcurrent) (*4)	Current more than 150% of the rated inverter current flew in the motor and operation is being performed to prevent the inverter from resulting in overcurrent shut-off.
oL (oL)	Stall prevention (overvoltage)	Regenerative energy of the motor became excessive and operation is being performed to stop the frequency from decreasing to prevent overvoltage shut-off.
PS (PS)	PU stop	Pr. 75 "reset selection/PU stop selection" had been set and a stop was made by pressing the  of the operation panel or parameter unit (FR-PU04). Restarting method with PS shown (PU stop) 1) Switch STF (STR) off. 2) Press the  to change to PU (PS cancel). 3) Press the  to return to EXT. 4) Switch STF (STR) on.
UV (UV)	Undervoltage	Power supply voltage of the inverter dropped.
$Err.$ (Err)	During reset	During inverter reset (RES signal is ON)

*4. The stall prevention operation current may be set to any value. It is factory set to 150%.

(4) Write errors

Operation Panel Indication	Function Name	Definition
$Er 1$ (Er1)	Write disable error	<ul style="list-style-type: none"> Write was performed with "1" set in Pr. 77 Frequency jump setting range overlapped. Parameter write was performed though the operation panel does not have the write precedence.
$Er 2$ (Er2)	Write-while-running error/mode designation error	<ul style="list-style-type: none"> Write was performed during operation. An attempt was made to change the Pr. 79 setting to the operation mode where the run command has been input. Write was performed in external operation mode.
$Er 3$ (Er3)	Calibration error	Analog input bias and gain calibration values are too close.

- Major failure: When the protective function is activated, the inverter output is shut-off and an alarm output is provided.
- Minor failure: When the protective function is activated, the output is not shut off. The minor failure signal can be output by making parameter setting. (Set "98" in Pr. 64 or Pr. 65 (output terminal function selection). Refer to page 57 .)

7.2 Checking of the alarm history

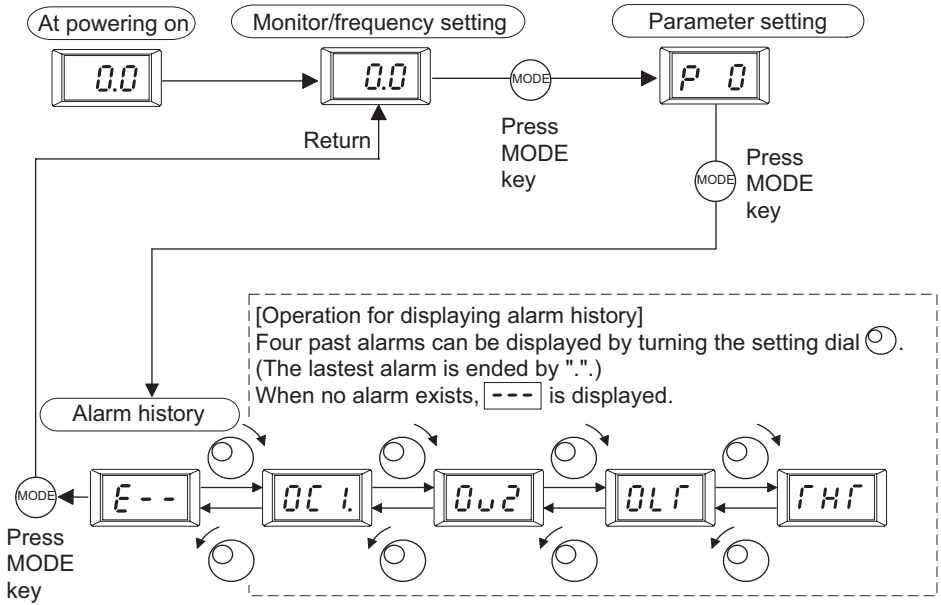

7.3 To know the operating status at the occurrence of alarm (only when FR-PU04 is used)

When any alarm has occurred, the display automatically switches to the indication of the corresponding protective function (error). By pressing the **(MON)** at this point without resetting the inverter, the display shows the output frequency. In this way, it is possible to know the running frequency at the occurrence of the alarm. It is also possible to know the current in the same manner. After resetting, you can confirm the definitions in "Alarm History". (For details, refer to the instruction manual of the parameter unit (FR-PU04).)

7.4 Correspondence between digital and actual characters

There are the following correspondences between the actual alphanumeric characters and the digital characters displayed on the operation panel:

Actual	Display
0	0
1	1
2	2
3	3
4	4
5	5
6	6
7	7
8	8
9	9

Actual	Display
A	A
B	b
C	C
D	d
E	E
F	F
G	G
H	H
I	I
J	J
L	L

Actual	Display
M	m
N	n
O	O
o	o
P	P
S	S
T	T
U	U
V	V
r	r
-	-

7.5 Resetting the inverter

The inverter can be reset by performing any of the following operations. Note that the internal thermal integrated value of the electronic thermal relay function and the number of retries are cleared (erased) by resetting the inverter.

Recover about 1s after reset is cancelled.

Err (Err) flickers on the operation panel during reset.

Operation 1 Using the operation panel, perform a reset with the **(STOP RESET)**.

(Enabled only when the inverter protective function is activated (major failure))

Operation 2 Switch power off once, then switch it on again after the LED on the operation panel turns off.

Operation 3 Turn on the reset signal (RES). (Assign this signal using any of Pr. 60 to Pr. 63.) (Refer to page 57.)

7.6 Troubleshooting

POINTS

If the cause is still unknown after every check, it is recommended to initialize the parameters (return to factory setting) then reset the required parameter values and check again.

7.6.1 Motor remains stopped

1) Check the main circuit

- Check that a proper power supply voltage is applied (operation panel display is provided).
- Check that the motor is connected properly.
- Check that the jumper across P-P1 is connected.

2) Check the input signals

- Check that the start signal is input.
- Check that both the forward and reverse rotation start signals are not input simultaneously.
- Check that the frequency setting signal is not zero.
- Check that the AU signal is on when the frequency setting signal is 4 to 20mA.
- Check that the output stop signal (MRS) or reset signal (RES) is not on. (Assign signals MRS and RES using Pr. 60 to Pr. 63 (input terminal function selection).)
- Check that the sink or source jumper connector is fitted securely.

3) Check the parameter settings

- Check that the reverse rotation prevention (Pr. 78) is not selected.
- Check that the operation mode (Pr. 79) setting is correct.
- Check that the bias and gain (C2 to C7) settings are correct.
- Check that the starting frequency (Pr. 13) setting is not greater than the running frequency.
- Check that various operational functions (such as three-speed operation), especially the maximum frequency (Pr. 1), are not zero.

4) Check the load

- Check that the load is not too heavy.
- Check that the shaft is not locked.

5) Others

- Check that the operation panel display does not show an error (e.g. OC1).
- Check that the Pr. 15 "jog frequency" setting is not lower than the Pr. 13 "starting frequency" value.

7.6.2 Motor rotates in opposite direction

- Check that the phase sequence of output terminals U, V and W is correct.
- Check that the start signals (forward rotation, reverse rotation) are connected properly.
- Check the setting of Pr. 17 "RUN key rotation direction selection".

7.6.3 Speed greatly differs from the setting

- Check that the frequency setting signal is correct. (Measure the input signal level.)
- Check that the following parameter settings are correct (Pr. 1, Pr. 2, Pr. 19, Pr. 38, Pr. 39, Pr. 95, C2 to C7).
- Check that the input signal lines are not affected by external noise. (Use shielded cables)
- Check that the load is not too heavy.

7.6.4 Acceleration/deceleration is not smooth

- Check that the acceleration and deceleration time settings are not too short.
- Check that the load is not too heavy.
- Check that the torque boost setting is not too large to activate the stall prevention function.

7.6.5 Motor current is large

- Check that the load is not too heavy.
- Check that the torque boost setting is not too large.
- Check that the rated motor frequency is set in the Pr. 3 "base frequency".

7.6.6 Speed does not increase

- Check that the maximum frequency setting is correct.
- Check that the load is not too heavy. (In agitators, etc., load may become heavier in winter.)
- Check that the torque boost setting is not too large to activate the stall prevention function.
- Check that the brake resistor is not connected to terminals P-P1 or terminals PR-P1 accidentally. (FR-S520E-0.4K to 3.7K)

7.6.7 Speed varies during operation

When slip compensation is selected, the output frequency varies with load fluctuation between 0 and 2Hz. This is a normal operation and is not a fault.

1) Inspection of load

- Check that the load is not varying.

2) Inspection of input signal

- Check that the frequency setting signal is not varying.
- Check that the frequency setting signal is not affected by noise.
- Check for a malfunction due to an undesirable current when the transistor output unit is connected.

3) Others

- Check that the wiring length is not too long.
- Check that GD² load is not small. (at the motor GD² or smaller)
..... FR-S540E-1.5K to 3.7K
If so, set the Pr. 72 "PWM frequency selection" to 6kHz or higher.
(Check for noise or leakage current problem.)

7.6.8 Operation mode is not changed properly



If the operation mode does not change correctly, check the following:

- 1. External input signal Check that the STF or STR signal is off. When it is on, the operation mode cannot be changed.
- 2. Parameter setting Check the Pr. 79 setting. When the Pr. 79 "operation mode selection" setting is "0", switching input power on places the inverter in external operation mode. Press the  to switch to PU operation mode. For other settings (1 to 8), the operation mode is limited accordingly. (For details of Pr. 79, refer to page 49.)

7.6.9 Operation panel display is not operating

- Make sure that terminals PC-SD are not shorted.
- Make sure that the connector is fitted securely across terminals P-P1.

7.6.10 Parameter write cannot be performed

- Make sure that operation is not being performed (signal STF or STR is not ON).
- Check that the  () was pressed.
- Make sure that you are not attempting to set the parameter outside the setting range.
- Make sure that you are not attempting to set the parameter in external operation mode.
- Check Pr. 77 "parameter write disable selection".

7.6.11 Motor produces annoying sound

- Check the Pr. 70 "Soft-PWM setting" and Pr. 72 "PWM frequency selection" settings.
- Make sure that the deceleration time is not too short.

7.7 Precautions for maintenance and inspection

The inverter is a static unit mainly consisting of semiconductor devices. Daily inspection must be performed to prevent any fault from occurring due to the adverse effects of the operating environment, such as temperature, humidity, dust, dirt and vibration, changes in the parts with time, service life, and other factors.

7.7.1 *Precautions for maintenance and inspection*

For some short time after the power is switched off, a high voltage remains in the smoothing capacitor. When accessing the inverter for inspection, wait for at least 10 minutes after the power supply has been switched off, and then make sure that the voltage across the main circuit terminals P-N of the inverter is not more than 30VDC using a tester, etc.

7.7.2 *Inspection item*

(1) Daily inspection

- Basically, check for the following faults during operation.
 - 1) Motor operation fault
 - 2) Improper installation environment
 - 3) Cooling system fault
 - 4) Abnormal vibration, abnormal noise
 - 5) Abnormal overheat, discoloration
- During operation, check the inverter input voltages using a tester.

(2) Cleaning

Always run the inverter in a clean status.

When cleaning the inverter, gently wipe dirty areas with a soft cloth immersed in neutral detergent or ethanol.

CAUTION

Do not use solvent, such as acetone, benzene, toluene and alcohol, as they will cause the inverter surface paint to peel off.

7.7.3 *Periodic inspection*

Check the areas inaccessible during operation and requiring periodic inspection. Consult us for periodic inspection.

- 1) Cooling system fault. Clean the air filter, etc.
- 2) Tightening check and retightening The screws and bolts may become loose due to vibration, temperature changes, etc. Check and tighten them. Tighten them according to the specified tightening torque.
- 3) Check the conductors and insulating materials for corrosion and damage.
- 4) Measure insulation resistance.
- 5) Check and replace the cooling fan, smoothing capacitor and relay.

7.7.4 Daily and periodic inspection

Area of Inspection	Inspection Item	Inspection Item	Interval		Corrective Action at Alarm Occurrence	Customer's Check
			Daily	Periodic *2		
General	Surrounding environment	Check the ambient temperature, humidity, dirt, corrosive gas, oil mist, etc	○		Improve environment	
	Overall unit	Check for unusual vibration and noise	○		Check alarm location and retighten	
	Power supply voltage	Check that the main circuit voltages and control voltages are normal *1	○		Inspect the power supply	
Main circuit	General	(1) Check with megger (across main circuit terminals and earth (ground) terminal). (2) Check for loose screws and bolts. (3) Check for overheat traces on the parts. (4) Check for stain		○ ○ ○ ○	Contact the manufacturer Retighten Contact the manufacturer Clean	
	Conductors, cables	(1) Check conductors for distortion. (2) Check cable sheaths for breakage and deterioration (crack, discoloration, etc.)		○ ○	Contact the manufacturer Contact the manufacturer	
	Transformer/reactor	Check for unusual odor and abnormal increase in whining sound.	○		Stop the device and contact the manufacturer.	
	Terminal block	Check for damage.		○	Stop the device and contact the manufacturer.	
	Smoothing aluminum electrolytic capacitor	(1) Check for liquid leakage. (2) Check for safety valve projection and bulge.		○ ○	Contact the manufacturer Contact the manufacturer	
	Relay/contactor	Check that the operation is normal and no chatter is heard.		○	Contact the manufacturer	
	Resistor	(1) Check for crack in resistor insulation. (2) Check for a break in the cable.		○ ○	Contact the manufacturer Contact the manufacturer	

Precautions for maintenance and inspection

Area of Inspection	Inspection Item	Inspection Item	Interval		Corrective Action at Alarm Occurrence	Customer's Check
			Daily	Periodic *2		
Control circuit / protective circuit	Operation check	(1) Check that the output voltages across phases with the inverter operated alone is balanced		○	Contact the manufacturer	
		(2) Check that no fault is found in protective and display circuits in a sequence protective operation test.		○	Contact the manufacturer	
	Parts check	Overall	(1) Check for unusual odor and discoloration. (2) Check for serious rust development		○ ○	
Aluminum electrolytic capacitor		Check for liquid leakage in a capacitor and deformation trace		○	Contact the manufacturer	
Cooling system	Cooling fan	(1) Check for unusual vibration and noise. (2) Check for loose screws and bolts (3) Check for stain	○	○ ○ ○	Replace the fan Retighten Clean	
	Heatsink	(1) Check for clogging (2) Check for stain		○ ○	Clean Clean	
	Air filter, etc.	(1) Check for clogging (2) Check for stain		○ ○	Clean or replace Clean or replace	
Display	Indication	(1) Check that display is normal. (2) Check for stain	○	○	Contact the manufacturer Clean	
	Meter	Check that reading is normal	○		Stop the device and contact the manufacturer.	
Load motor	Operation check	Check for vibration and abnormal increase in operation noise	○		Stop the device and contact the manufacturer.	

*1 It is recommended to install a device to monitor voltage for checking the power supply voltage to the inverter.

*2 One to two years of periodic inspection cycle is recommended. However, it differs according to the installation environment.
Consult us for periodic inspection.

7.7.5 Replacement of parts

The inverter consists of many electronic parts such as semiconductor devices. The following parts may deteriorate with age because of their structures or physical characteristics, leading to reduced performance or fault of the inverter. For preventive maintenance, the parts must be replaced periodically.

Part Name	Standard Replacement Interval	Description
Cooling fan	2 to 3 years	Replace (as required)
Main circuit smoothing capacitor	10 years *	Replace (as required)
On-board smoothing capacitor	10 years *	Replace the board (as required)
Relays	—	Replace as required

*The design life of electrolytic capacitor is about ten years (36000h) if used for 10 hours a day and 365 days a year in the average yearly ambient temperature of 40°C .

CAUTION

For parts replacement, consult the nearest Mitsubishi FA Center.

(1) Cooling fan

The cooling fan is used to cool heat-generating parts such as the main circuit semiconductors. The life of the cooling fan bearing is usually 10,000 to 35,000 hours. Hence, the cooling fan must be replaced every 2 to 3 years if the inverter is run continuously. When unusual noise and/or vibration is noticed during inspection, the cooling fan must be replaced immediately.

Inverter Type	Fan Type
FR-S520E-1.5K, 2.2K, 3.7K, FR-S520SE-1.5K	MMF-06D24DS BKO-C2461H07
FR-S540E-1.5K, 2.2K, 3.7K	MMF-06D24ES-FC4 BKO-CA1027H09

●Removal

1) Remove the front cover and wiring cover.

2) Unplug the fan connectors.

The cooling fan is connected to the cooling fan connector beside the main circuit terminal block of the inverter.

Unplug the connector and separate the inverter from the cooling fan.

3) Remove the cooling fan cover.

Disengage the fixing hooks pointed by arrows to remove the cooling fan cover.

4) Remove the cooling fan and cooling fan cover.

The cooling fan is secured by the fixing hooks.

Disengage the fixing hooks to remove the cooling fan and cooling fan cover.

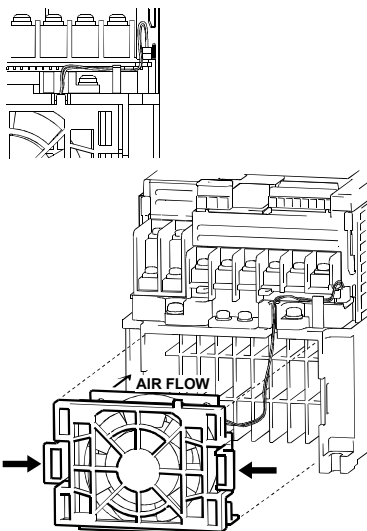

●Reinstallation

1) After confirming the orientation of the fan, reinstall the fan so that the arrow on the left of "AIR FLOW" faces up.

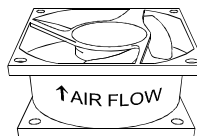

CAUTION
Installing the fan in the opposite air flow direction can cause the inverter life to be shorter.

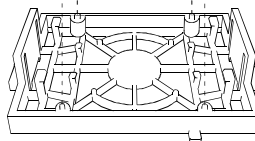

2) Reinstall the fan cover to the inverter.

Run the cable through the wiring groove to prevent it from being caught between the chassis and cover.

3) Reconnect the cable to the connector. (Refer to "Removal" for the position of the connector.)

4) Reinstall the wiring cover.

(2) Smoothing capacitors

A large-capacity aluminum electrolytic capacitor is used for smoothing in the main circuit DC section, and an aluminum electrolytic capacitor is used for stabilizing the control power in the control circuit. Their characteristics are deteriorated by the adverse effects of ripple currents, etc. The replacement intervals greatly vary with the ambient temperature and operating conditions. When the inverter is operated in air-conditioned, normal environment conditions, replace the capacitors about every 10 years.

When a certain period of time has elapsed, the capacitors will deteriorate more rapidly. Check the capacitors at least every year (less than six months if the life will be expired soon).

The appearance criteria for inspection are as follows:

- 1) Case: Check the side and bottom faces for expansion
- 2) Sealing plate: Check for remarkable warp and extreme crack.
- 3) Check for external crack, discoloration, fluid leakage, etc. Judge that the capacitor has reached its life when the measured capacitance of the capacitor reduced below 85% of the rating.

(3) Relays

To prevent a contact fault, etc., relays must be replaced according to the cumulative number of switching times (switching life).

8. SPECIFICATIONS

8.1 Ratings

(1) Three-phase 200V power supply

Type FR-S520E-□K (-C)	0.1	0.2	0.4	0.75	1.5	2.2	3.7
Applied motor capacity (kW) (*1)	0.1	0.2	0.4	0.75	1.5	2.2	3.7
Output	Rated capacity (kVA) (*2)	0.3	0.5	1.0	1.6	2.8	6.6
	Rated current (A)	0.8	1.4	2.5	4.1	7.0	16.5
	Overload current rating (*3)	150% 60s, 200% 0.5s (inverse time characteristics)					
	Voltage (*4)	Three-phase 200 to 240V					
Power supply	Rated input AC voltage/frequency	Three-phase 200 to 240V 50Hz/60Hz					
	Permissible AC voltage fluctuation	170 to 264V 50Hz/60Hz					
	Permissible frequency fluctuation	Within $\pm 5\%$					
	Power supply system capacity (kVA) (*5)	0.4	0.7	1.2	2.1	4.0	5.5
Protective structure (JEM1030)	Enclosed type (IP20), IP40 for totally enclosed structure series						
Cooling system	Self-cooling				Forced air cooling		
Approximate mass (kg)	0.5	0.5	0.8	0.9	1.5	1.5	2.1

- *1. The applied motor capacity indicated is the maximum capacity applicable for use of the Mitsubishi 4-pole standard motor.
- *2. The rated output capacity indicated assumes that the output voltage is 230V.
- *3. The % value of the overload current rating indicated is the ratio of the overload current to the inverter's rated output current.
For repeated duty, allow time for the inverter and motor to return to or below the temperatures under 100% load.
- *4. The maximum output voltage does not exceed the power supply voltage. You can set the maximum output voltage to any value below the power supply voltage. However, the pulse voltage value of the inverter output side voltage remains unchanged at about $\sqrt{2}$ that of the power supply.
- *5. The power supply capacity changes with the values of the power supply side inverter impedances (including those of the input reactor and cables).

(2) Three-phase 400V power supply

Type FR-S540E-□K	0.4	0.75	1.5	2.2	3.7	
Applied motor capacity (kW) (*1)	0.4	0.75	1.5	2.2	3.7	
Output	Rated capacity (kVA) (*2)	0.9	1.6	2.7	3.7	5.9
	Rated current (A)	1.1	2.1	3.5	4.8	7.7
	Overload current rating (*3)	150% 60s, 200% 0.5s (Inverse time characteristics)				
	Voltage (*4)	Three phase, 380V to 480V				
Power supply	Rated input AC voltage/frequency	Three phase, 380V to 480V 50Hz/60Hz				
	Permissible AC voltage fluctuation	325 to 528V 50Hz/60Hz				
	Permissible frequency fluctuation	±5%				
	Power supply system capacity (kVA) (*5)	1.5	2.5	4.5	5.5	9.5
Protective structure (JEM1030)	Enclosed type (IP20)					
Cooling system	Self-cooling		Forced air cooling			
Approximate mass (kg)	1.5	1.5	1.5	1.6	1.7	

- *1. The applied motor capacity indicated is the maximum capacity applicable for use of the Mitsubishi 4-pole standard motor.
- *2. The rated output capacity indicated assumes that the output voltage is 440V.
- *3. The % value of the overload current rating indicated is the ratio of the overload current to the inverter's rated output current.
For repeated duty, allow time for the inverter and motor to return to or below the temperatures under 100% load.
- *4. The maximum output voltage does not exceed the power supply voltage. You can set the maximum output voltage to any value below the power supply voltage. However, the pulse voltage value of the inverter output side voltage remains unchanged at about $\sqrt{2}$ that of the power supply.
- *5. The power supply capacity varies with the value of the power supply side inverter impedance (including those of the input reactor and cables).

(3) Single-phase 200V power supply

Type FR-S520SE-□K		0.1	0.2	0.4	0.75	1.5
Applied motor capacity (kW) (*1)		0.1	0.2	0.4	0.75	1.5
Output	Rated capacity (kVA) (*2)	0.3	0.5	1.0	1.6	2.8
	Rated current (A)	0.8	1.4	2.5	4.1	7.0
	Overload current rating (*3)	150% 60s, 200% 0.5s (Inverse time characteristics)				
	Voltage (*4)	Three phase, 200V to 240V				
Power supply	Rated input AC voltage/frequency	Single-phase, 200V to 240V 50Hz/60Hz				
	Permissible AC voltage fluctuation	170 to 264V 50Hz/60Hz				
	Permissible frequency fluctuation	±5%				
	Power supply system capacity (kVA) (*5)	0.5	0.9	1.5	2.5	4.4
Protective structure (JEM1030)		Enclosed type (IP20)				
Cooling system		Self-cooling				Forced air cooling
Approximate mass (kg)		0.5	0.6	0.8	1.0	1.5

- *1. The applied motor capacity indicated is the maximum capacity applicable when a Mitsubishi 4-pole standard motor is used.
- *2. The rated output capacity indicated assumes that the output voltage is 230V.
- *3. The % value of the overload current rating indicated is the ratio of the overload current to the inverter's rated output current.
For repeated duty, allow time for the inverter to return to or below the temperatures under 100% load.
- *4. The maximum output voltage does not exceed the power supply voltage. The maximum output voltage may be set as desired below the power supply voltage. However, the PWM pulse voltage value of the inverter output side voltage remains unchanged at about $\sqrt{2}$ that of the power supply.
- *5. The power supply capacity changes with the values of the power supply side inverter impedances (including those of the input reactor and cables).

(4) Single-phase 100V power supply

Type FR-S510WE-□K	0.1	0.2	0.4	0.75	
Applied motor capacity (kW) (*1)	0.1	0.2	0.4	0.75	
Output	Rated capacity (kVA) (*2)	0.3	0.5	1.0	1.6
	Rated current (A)	0.8	1.4	2.5	4.1
	Overload current rating (*3)	150% 60s, 200% 0.5s (Inverse time characteristics)			
	Voltage	Three phase, 200V to 230V (*4, 6)			
Power supply	Rated input AC voltage/frequency	Single-phase, 100V to 115V 50Hz/60Hz			
	Permissible AC voltage fluctuation	90 to 132V 50Hz/60Hz			
	Permissible frequency fluctuation	±5%			
	Power supply system capacity (kVA) (*5)	0.5	0.9	1.5	2.5
Protective structure (JEM1030)	Enclosed type (IP20)				
Cooling system	Self-cooling				
Approximate mass (kg)	0.6	0.7	0.9	1.6	

- *1. The applied motor capacity indicated is the maximum capacity applicable when a Mitsubishi 4-pole standard motor is used.
- *2. The rated output capacity indicated assumes that the output voltage is 230V.
- *3. The % value of the overload current rating indicated is the ratio of the overload current to the inverter's rated output current.
For repeated duty, allow time for the inverter to return to or below the temperatures under 100% load.
- *4. For single-phase 100V power input, the output voltage provided cannot be twice or more than the power supply voltage.
- *5. The power supply capacity changes with the values of the power supply side inverter impedances (including those of the input reactor and cables).
- *6. For single-phase 100V power input, the application of motor load reduces the output voltage about 10 to 15%. Therefore, the load must be reduced when a general-purpose motor is used.

8.2 Common specifications

Control specifications	Control method		Selectable between Soft-PWM control and high carrier frequency PWM control, selectable between V/F control and automatic torque boost control.
	Output frequency range		0.5 to 120Hz (starting frequency variable between 0 and 60Hz)
	Frequency setting resolution		5VDC input: 1/500 of max. set frequency, 10VDC, 4 to 20mADC input: 1/1000 of max. set frequency Digital input: 0.1Hz (less than 100Hz), 1Hz (100Hz or higher)
	Frequency accuracy		Analog input: Within $\pm 1\%$ of max. output frequency ($25^{\circ}\text{C} \pm 10^{\circ}\text{C}$) Digital input: Within $\pm 0.5\%$ of set output frequency (when set by the setting dial)
	Starting torque		150% (at 5Hz) during automatic torque boost control
	Acceleration/deceleration time setting		0, 0.1 to 999s (acceleration and deceleration can be set individually), linear or S-pattern acceleration/deceleration mode can be selected.
	Braking torque (*2)	Regeneration	0.1K, 0.2K ... 150%, 0.4K, 0.75K ... 100%, 1.5K ... 50%, 2.2K, 3.7K ... 20%
		DC injection brake	Operation frequency (0 to 120Hz), operation time (0 to 10s), operation voltage (0 to 15%)
	Frequency setting signal	Analog input	0 to 5VDC, 0 to 10VDC, 4 to 20mA
		Digital input	Entered from operation panel
	Start signal	STF, STR	Forward and reverse rotation, start signal automatic self-holding input (3-wire input) can be selected.
	Reset		Reset the alarm output when the protective function is activated.
	Multi-speed selection		Up to 15 speeds can be selected. (Each speed can be set between 0 and 120Hz, running speed can be changed during operation from the operation panel.)
	Second function selection		Used to select second functions (acceleration time, deceleration time, torque boost, base frequency, electronic thermal relay function).
	Output stop		Instantaneous shut-off of inverter output (frequency, voltage)
Current input selection		Used to select frequency setting signal 4 to 20 mA (terminal 4).	
External thermal relay input		Thermal relay contact input for use when the inverter is stopped by the external thermal relay.	
Jog signal		Jog operation mode selection	
PID control valid		Selection for exercising PID control	
PU operation /external operation switchover		Used to switch between PU operation and external operation from outside the inverter.	
			Use Pr. 60 to Pr. 63 for selection

Control specifications	Operational functions		Maximum and minimum frequency settings, frequency jump operation, external thermal relay input selection, automatic restart after instantaneous power failure, forward/reverse rotation prevention, slip compensation, operation mode selection, PID control, computer link operation (RS-485).	
	Output signals	Operating Status	1 open collector signal can be selected from among inverter running, up-to-frequency, frequency detection, overload warning, zero current detection, output current detection, PID upper limit, PID lower limit, PID forward/reverse rotation, operation ready, current average value monitor signal, maintenance timer alarm, minor failure and alarm. 1 contact output (1 changeover contact, 230V 0.3AAC, 30V 0.3ADC) signal can be selected.	Use Pr. 64 and Pr. 65 for selection
		For meter	1 signal can be selected from between output frequency and motor current. Pulse train output (1440 pulses/s, 1mA full scale)	
Protective/warning function			Overcurrent shut-off (during acceleration, deceleration, constant speed), regenerative overvoltage shut-off (during acceleration, deceleration, constant speed), overload shut-off (electronic thermal relay function), heatsink overheat, fan failure (*3), stall prevention, brake transistor alarm (*4), start-time output side earth (ground) fault protection (*5), external thermal relay (*6), disconnected PU, retry count over, communication error, CPU error, undervoltage (*1)	
Environment	Ambient temperature		-10°C to +50°C (non-freezing) (-10°C to +40°C for totally enclosed structure feature)	
	Ambient humidity		90%RH or less (non-condensing)	
	Storage temperature (*7)		-20°C to +65°C	
	Atmosphere		Indoors (without corrosive gas, flammable gas, oil mist, dust and dirt etc.)	
	Altitude, vibration		Maximum 1000m above seal level, 5.9m/s ² or less	

- *1. When undervoltage or instantaneous power failure occurs, no alarm output is provided but the output is shut off. After power restoration, the inverter may be run as it is. Depending on the running status (e.g. load magnitude), however, overcurrent, regenerative overvoltage or other protection may be activated at power restoration. (in the external operation mode)
- *2. The braking torque indicated is a short-duration average torque (which varies with motor loss) when the motor alone is decelerated from 60Hz in the shortest time and is not a continuous regenerative torque. When the motor is decelerated from the frequency higher than the base frequency, the average deceleration torque will reduce. Since the inverter does not contain a brake resistor, use an optional brake resistor when regenerative energy is large. (Available for the FR-S520E-0.4K to 3.7K only.) A brake unit (BU) may also be used.
- *3. Compatible with only the product having the built-in cooling fan.
- *4. Available for the FR-S520E-0.4K to 3.7K only.
- *5. Activated only when "1" is set in Pr. 40 "start-time earth (ground) fault detection selection".
- *6. Activated only when external thermal relay input (OH) is selected in any of Pr. 60 to Pr. 63 (input terminal function selection).
- *7. Temperature applicable for a short period such as transportation.

9. OUTLINE DIMENSION DRAWINGS

- FR-S520E-0.1K, 0.2K, 0.4K, 0.75K
- FR-S520SE-0.1K, 0.2K, 0.4K, 0.75K
- FR-S510WE-0.1K, 0.2K, 0.4K

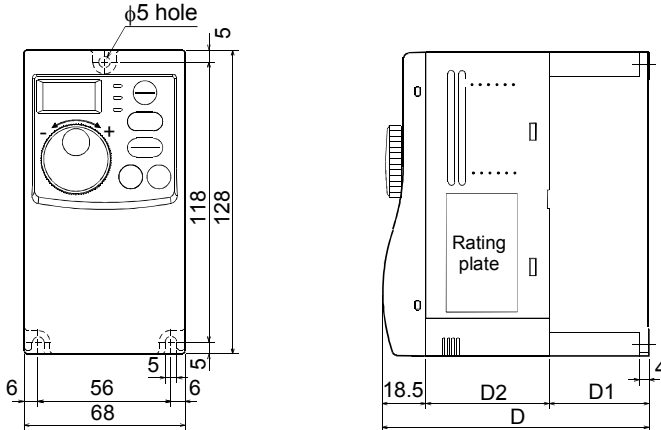

- Three-phase 200V power supply

Capacity	D	D1	D2
0.1K,0.2K	80.5	10	52
0.4K	112.5	42	52
0.75K	132.5	62	52

- Single-phase 200V power supply

Capacity	D	D1	D2
0.1K,0.2K	80.5	10	52
0.4K	142.5	42	82
0.75K	162.5	62	82

- Single-phase 100V power supply

Capacity	D	D1	D2
0.1K	80.5	10	52
0.2K	110.5	10	82
0.4K	142.5	42	82

(Unit: mm)

REMARKS

For dimensions of the totally enclosed structure type, refer to those of the standard type inverter of the same capacity.

- FR-S520E-1.5K, 2.2K, 3.7K
- FR-S540E-0.4K, 0.75K, 1.5K, 2.2K, 3.7K
- FR-S520SE-1.5K
- FR-S510WE-0.75K

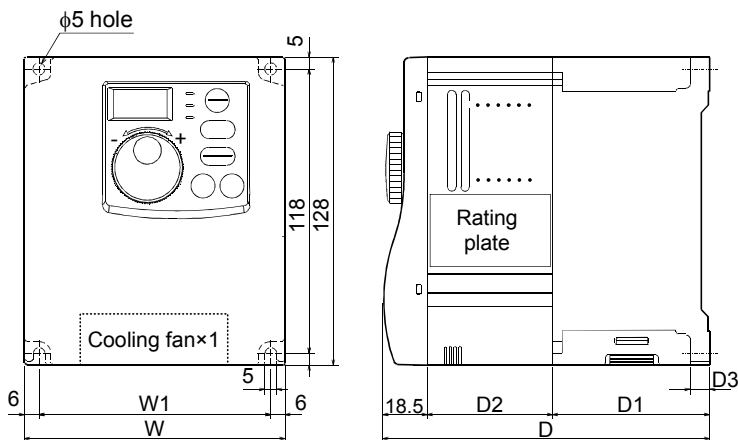

•Three-phase 200V power supply

Capacity	W	W1	D	D1	D2	D3
1.5K,2.2K	108	96	135.5	65	52	8
3.7K	170	158	142.5	72	52	5

•Three-phase 400V power supply

Capacity	W	W1	D	D1	D2	D3
0.4K,0.75K	108	96	129.5	59	52	5
1.5K	108	96	135.5	65	52	8
2.2K	108	96	155.5	65	72	8
3.7K	108	96	165.5	65	82	8

•Single-phase 200V power supply

Capacity	W	W1	D	D1	D2	D3
1.5K	108	96	155.5	65	72	8

•Single-phase 100V power supply

Capacity	W	W1	D	D1	D2	D3
0.75K	108	96	149.5	59	72	5

(Unit: mm)

REMARKS

- The FR-S540E-0.4K, 0.75K and FR-S510WE-0.75K do not have a cooling fan.
- For dimensions of the totally enclosed structure type, refer to those of the standard type inverter of the same capacity.

•Parameter unit (FR-PU04)

<Outline drawing>

<Panel cut dimension drawing>

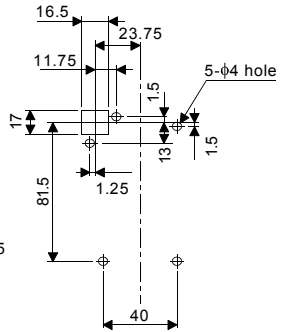
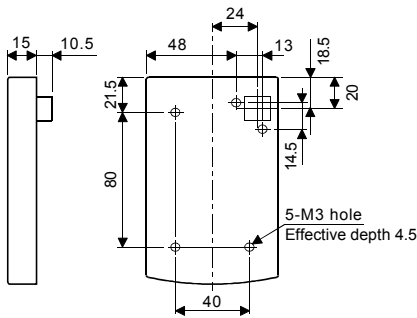
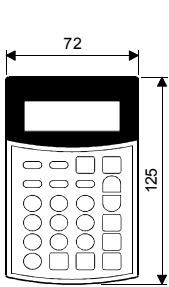

(Unit:mm)

Choose the mounting screws whose length will not exceed the effective depth of the mounting threads.

Appendix 1 Instructions for compliance with the European Directive

(The products conforming to the Low Voltage Directive carry the CE mark.)

(1) EMC Directive

1) Our view of transistorized inverters for the EMC Directive

A transistorized inverter is a component designed for installation in an enclosure and for use with the other equipment to control the equipment/device. Therefore, we understand that the EMC Directive does not apply directly to transistorized inverters. For this reason, we do not place the CE mark on the transistorized inverters. (The CE mark is placed on inverters in accordance with the Low Voltage Directive.) The European power drive manufacturers' organization (CEMEP) also holds this point of view.

2) Compliance

We understand that the transistorized inverters are not covered directly by the EMC Directive. However, the EMC Directive applies to machines/equipment into which transistorized inverters have been incorporated, and these machines and equipment must carry the CE marks. Hence, we prepared the European Standard-compliant noise filters and the technical information "EMC Installation Guidelines" (information number BCN-A21041-202) so that machines and equipment incorporating transistorized inverters may conform to the EMC Directive more easily.

3) Outline of installation method

Install an inverter using the following methods:

- * Use the inverter with an European Standard-compliant noise filter.
- * For wiring between the inverter and motor, use shielded cables or run them in a metal piping and earth (ground) the cables on the inverter and motor sides with the shortest possible distance.
- * Insert a common mode filter and ferrite core into the power and control lines as required.

Full information including the European Standard-compliant noise filter specifications are written in the technical information "EMC Installation Guidelines" (BCN-A21041-202). Please contact your sales representative.

(2) Low Voltage Directive

1) Our view of transistorized inverters for the Low Voltage Directive

Transistorized inverters are covered by the Low Voltage Directive (Standard to conform to: EN50178).

2) Compliance

We have self-confirmed our inverters as products compliant to the Low Voltage Directive and place the CE mark on the inverters.

3) Outline of instructions

- * For the 400V class inverter, the rated input voltage range is three-phase 380V to 415V 50Hz/60Hz.
- * Do not use an earth leakage circuit breaker as an electric shock protector without connecting the equipment to the earth. Connect the equipment to the earth securely.
- * Wire the earth terminal independently. (Do not connect two or more cables to one terminal.)
- * Use the cable sizes on page 11 under the following conditions.
 - Ambient temperature: 40°C maximum
 - Wire installation: On wall without ducts or conduitsIf conditions are different from above, select appropriate wire according to EN60204 ANNEX C TABLE 5.
- * Use the moulded case circuit breaker and magnetic contactor which conform to the EN or IEC Standard.
- * Use the breaker of type B (breaker which can detect both AC and DC). If not, provide double or enhanced insulation between the inverter and other equipment, or put a transformer between the main power supply and inverter.
- * Use the inverter under the conditions of overvoltage category II and contamination level 2 or higher specified in IEC664.
- * On the input and output of the inverter, use cables of the type and size set forth in EN60204 Appendix C.
- * The operating capacity of the relay outputs (terminal symbols A, B, C) should be 30VDC, 0.3A.
- * Control circuit terminals on page 7 are safely isolated from the main circuit.
- * Environment

	During operation	In storage	During transportation
Ambient Temperature	-10°C to +50°C	-20°C to +65°C	-20°C to +65°C
Ambient Humidity	90% RH or less	90% RH or less	90% RH or less
Maximum Altitude	1,000m	1,000m	10,000m

Details are given in the technical information "Low Voltage Directive Conformance Guide" (BCN-A21041-203). Please contact your sales representative.

Appendix 2 Instructions for UL and cUL

(Standard to comply with: UL 508C, CSA C22.2 No.14)



1. Installation

The S500E is UL-listed as a product for use in an enclosure.

Design the enclosure so that the ambient temperature, humidity and ambience of the inverter will satisfy the above specifications. (Refer to page 85)

Branch circuit protection

For installation in the United States, branch circuit protection must be provided in accordance with the National Electrical Code and any applicable local codes.

For installation in Canada, branch circuit protection must be provided in accordance with the Canada Electrical Code and any applicable provincial codes.

2. Wiring of the power supply and motor

For wiring the input (R, S, T) and output (U, V, W) terminals of the inverter, use the UL-listed copper wires (rated at 75°C) and round crimping terminals. Crimp the crimping terminals with the crimping tool recommended by the terminal maker.

3. Short circuit ratings

Suitable For Use in A Circuit Capable Of Delivering Not More Than 100kA rms Symmetrical Amperes.

4. Motor overload protection

These inverters provide solid state motor overload protection.

Set Pr. 9 using the following instructions,
(Pr. 9 "electronic thermal O/L relay").

<Setting>

- Set the rated current [A] of the motor in Pr. 9.
- Setting "0" in Pr. 9 disables electronic thermal relay function (motor protective function). (The protective function of the inverter is activated.)
- When using a Mitsubishi constant-torque motor, first set "1" in Pr. 71 "applied motor". (This provides a 100% continuous torque characteristic in the low-speed range.) Then, set the rated current of the motor in Pr. 9 "electronic thermal O/L relay".

CAUTION

- When two or more motors are connected to the inverter, they cannot be protected by the electronic thermal relay function. Install an external thermal relay to each motor.
- When a difference between the inverter and motor capacities is large and the setting becomes less than half amount of the inverter rated current, the protective characteristics of the electronic thermal relay function will be deteriorated. In this case, use an external thermal relay.
- A special motor cannot be protected by the electronic thermal relay function. Use an external thermal relay.

Reference: Motor overload protection characteristics

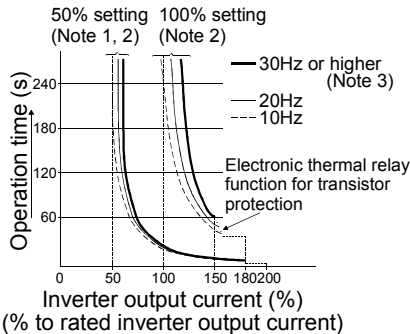

- Protection activating range
Range on the right of characteristic curve
- Normal operating range
Range on the left of characteristic curve

(Note 1) When you set the 50% value (current value) of the rated inverter output current.

(Note 2) The % value denotes the percentage of the current value to the rated inverter output current, not to the rated motor current.

(Note 3) This characteristic curve will be described even under operation of 6Hz or higher when you set the electronic thermal relay function dedicated to the Mitsubishi constant-torque motor.

MEMO

* The manual number is given on the bottom left of the back cover.

Print Date	*Manual Number	Revision
May, 2003	IB(NA)-0600151E-A	First edition
Aug., 2004	IB(NA)-0600151E-B	<div data-bbox="437 177 546 209" style="border: 1px solid black; padding: 2px;">Addition</div> Three-phase 400V power input specification, single-phase 200V power input specification, single-phase 100V power input specification
Jun, 2007	IB(NA)-0600151E-C	<div data-bbox="437 311 546 343" style="border: 1px solid black; padding: 2px;">Addition</div> <ul style="list-style-type: none"> • Explanation of frequency/start command <div data-bbox="437 384 624 416" style="border: 1px solid black; padding: 2px;">Partial changes</div> <ul style="list-style-type: none"> • Short circuit ratings (Instructions for UL and cUL Compliance)

 **For Maximum Safety**

- Mitsubishi transistorized inverters are not designed or manufactured to be used in equipment or systems in situations that can affect or endanger human life.
- When considering this product for operation in special applications such as machinery or systems used in passenger transportation, medical, aerospace, atomic power, electric power, or submarine repeating applications, please contact your nearest Mitsubishi sales representative.
- Although this product was manufactured under conditions of strict quality control, you are strongly advised to install safety devices to prevent serious accidents when it is used in facilities where breakdowns of the product are likely to cause a serious accident.
- Please do not use this product for loads other than three-phase induction motors.