



Changes for the Better

FX3UC-32MT-LT-2
PROGRAMMABLE CONTROLLERS
HARDWARE MANUAL

| | |
|---------------|-------------|
| Manual Number | JY997D31601 |
| Revision | A |
| Date | April 2008 |



This manual describes the part names, dimensions, mounting, cabling and specifications for the product. This manual is extracted from FX3UC Series User's Manual - Hardware Edition. Refer to FX3UC Series User's Manual - Hardware Edition details. Before use, read this manual and manuals of relevant products fully to acquire proficiency in the handling and operating the product. Make sure to learn all the product information, safety information, and precautions. And, store this manual in a safe place so that it can be taken out and read whenever necessary. Always forward it to the end user.

Registration
The company name and the product name to be described in this manual are the registered trademarks or trademarks of each company.

Effective April 2008
Specifications are subject to change without notice.
© 2008 Mitsubishi Electric Corporation

Safety Precaution (Read these precautions before use.)

This manual classifies the safety precautions into two categories:

⚠ DANGER and **⚠ CAUTION**.

| | |
|------------------|---|
| ⚠ DANGER | Indicates that incorrect handling may cause hazardous conditions, resulting in death or severe injury. |
| ⚠ CAUTION | Indicates that incorrect handling may cause hazardous conditions, resulting in medium or slight personal injury or physical damage. |

Depending on the circumstances, procedures indicated by **⚠ CAUTION** may also cause severe injury.

It is important to follow all precautions for personal safety.

| | |
|---|-----------------|
| STARTUP AND MAINTENANCE PRECAUTIONS | ⚠ DANGER |
| <ul style="list-style-type: none"> Do not touch any terminal while the PLC's power is on. Doing so may cause electric shock or malfunctions. Before cleaning or retightening terminals, cut off all phases of the power supply externally. Failure to do so may cause electric shock. Make sure to connect the battery for memory backup correctly. Do not charge, disassemble, heat, short-circuit, or expose the battery to fire. Doing so may rupture or ignite it. | |

| | |
|---|-----------------|
| STARTUP AND MAINTENANCE PRECAUTIONS | ⚠ DANGER |
| <ul style="list-style-type: none"> Before modifying or disrupting the program in operation or running the PLC, carefully read through this manual and the associated manuals and ensure the safety of the operation. An operation error may damage the machinery or cause accidents. | |

| | |
|---|------------------|
| STARTUP AND MAINTENANCE PRECAUTIONS | ⚠ CAUTION |
| <ul style="list-style-type: none"> Turn off the power to the PLC before attaching or detaching the memory cassette. If the memory cassette is attached or detached while the PLC's power is on, the data in the memory may be destroyed, or the memory cassette may be damaged. Do not disassemble or modify the PLC. Doing so may cause fire, equipment failures, or malfunctions. For repair, contact your local Mitsubishi Electric distributor. Turn off the power to the PLC before connecting or disconnecting any extension cable. Failure to do so may cause equipment failures or malfunctions. Turn off the power to the PLC before attaching or detaching the following devices. Failure to do so may cause equipment failures or malfunctions. <ul style="list-style-type: none"> Peripheral devices, display module, expansion boards. Extension blocks, connector conversion adapter, extension power supply units, special adapters, and FX Series terminal blocks. Battery and memory cassettes | |

| | |
|--|------------------|
| DISPOSAL PRECAUTIONS | ⚠ CAUTION |
| <ul style="list-style-type: none"> Please contact a certified electronic waste disposal company for the environmentally safe recycling and disposal of your device. | |

| | |
|---|------------------|
| TRANSPORT AND STORAGE PRECAUTIONS | ⚠ CAUTION |
| <ul style="list-style-type: none"> Before transporting the PLC, turn on the power to the PLC to check that the BAT LED is off. If the PLC is transported with the BAT LED on or the battery exhausted, the battery-backed data may be unstable during transportation. The PLC is a precision instrument. During transportation, avoid impacts larger than those specified in Section 2.1. Failure to do so may cause failures in the PLC. After transportation, verify the operations of the PLC. | |

Certification of UL, cUL standards

The FX3U(C) series and FX2N/FX2NC series input/output extension blocks supporting UL, cUL standards are as follows:
(For other products that correspond with the UL, cUL standards please refer to the FX3UC Series User's Manual - Hardware Edition or catalog.)

UL, cUL file number :E95239

Models : MELSEC FX3U(C) series manufactured

| | |
|------------------|------------------|
| FX3UC-32MT-LT-2 | FX3U-485ADP-(MB) |
| FX3U-232ADP-(MB) | FX3U-4DA-ADP |
| FX3U-4AD-ADP | FX3U-4AD-PTW-ADP |
| FX3U-4AD-PT-ADP | FX3U-4AD-TC-ADP |
| FX3U-4AD-TC-ADP | FX3U-1PS-5V |

Models : MELSEC FX2NC series manufactured
FX2NC-16EX FX2NC-32EX
FX2NC-16EYT FX2NC-32EYT
FX2NC-16EX-T FX2NC-16EYR-T

Models : MELSEC FX2N series manufactured
FX2N-8EX-UA1/UL FX2N-16EYS

Compliance with EC directive (CE Marking)

This document does not guarantee that a mechanical system including this product will comply with the following standards. Compliance to EMC directive and LVD directive of the entire mechanical system should be checked by the user / manufacturer. For more details please contact the local Mitsubishi Electric sales site.
(For other products that correspond with the EC directive please refer to the FX3UC Series User's Manual - Hardware Edition or catalog.)

Requirement for Compliance with EMC directive

The following products have shown compliance through direct testing (of the identified standards below) and design analysis (through the creation of a technical construction file) to the European Directive for Electromagnetic Compatibility (89/336/EEC) when used as directed by the appropriate documentation.

Type : Programmable Controller (Open Type Equipment)
Models : MELSEC FX3U(C) series and FX2NC series manufactured

| | | |
|---------------------|-----------------|-----------------|
| from May 1st, 2005 | FX3U-FLROM-16 | FX3U-FLROM-64L |
| from June 1st, 2005 | FX3U-232ADP | FX3U-485ADP |
| | FX3U-4AD-ADP | FX3U-4DA-ADP |
| | FX3U-4AD-PT-ADP | FX3U-4AD-TC-ADP |
| | FX3U-232-BD | FX3U-422-BD |
| | FX3U-485-BD | FX3U-CNV-BD |
| | FX3U-USB-BD | |
| | FX3U-FLROM-64 | |

| | | |
|------------------------|--------------------------|----------------|
| from April 1st, 2007 | FX3U-232ADP-MB | FX3U-485ADP-MB |
| from October 1st, 2007 | FX3UC-1PS-5V | |
| | FX2NC-**EX | FX2NC-**EYT |
| | Where ** indicates:16,32 | |
| | FX2NC-16EX-T | |

| | |
|-------------------------|------------------|
| from December 1st, 2007 | FX3U-4AD-PTW-ADP |
| from April 1st, 2008 | FX3UC-32MT-LT-2 |

| Standard | Remark |
|--|--|
| EN61131-2:2003 Programmable controllers - Equipment requirements and tests | Compliance with all relevant aspects of the standard. EMI <ul style="list-style-type: none"> Radiated Emissions Conducted Emissions EMS <ul style="list-style-type: none"> Radiated electromagnetic field Fast transient burst Electrostatic discharge High-energy surge Voltage drops and interruptions Conducted RF Power frequency magnetic field |

Models : MELSEC FX2NC series manufactured
from October 1st, 2007 FX2NC-**EX FX2NC-**EYT
Where ** indicates:16,32
FX2NC-16EX-T FX2NC-16EYR-T

| Standard | Remark |
|---|--|
| EN61000-6-4:2001 - Generic emission standard Industrial environment EN50081-2:1993 Electromagnetic compatibility | Compliance with all relevant aspects of the standard. <ul style="list-style-type: none"> Radiated Emissions Mains Terminal Voltage Emissions |
| EN61000-6-2:2001 - Generic immunity standard Industrial environment | Compliance with all relevant aspects of the standard. <ul style="list-style-type: none"> RF immunity Fast Transients ESD Conducted Surge Power magnetic fields Voltage drops and interruptions |

Requirement for Compliance with LVD directive

The following products have shown compliance through direct testing (of the identified standards below) and design analysis (through the creation of a technical construction file) to the European Directive for Low Voltage (73/23/EEC) when used as directed by the appropriate documentation.

Type : Programmable Controller (Open Type Equipment)
Models : MELSEC FX2NC series manufactured
from October 1st, 2007 FX2NC-16EYR-T

| Standard | Remark |
|---|--|
| IEC1010-1:1990 /A1:1992 BSEN61010-1:1993 * Safety requirements for electrical equipment for measurement, control, and laboratory use - General requirements | The equipment has been assessed as a component for fitting in a suitable enclosure which meets the requirements of IEC 1010-1:1990+A1:1992 |

* Compliance to BSEN61010-1 is claimed through virtue of direct compliance to IEC1010-1 and Amendment 1.

Caution for compliance with EC Directive

Installation in Enclosure

Programmable logic controllers are open-type devices that must be installed and used within conductive control boxes. Please use the FX3UC-32MT-LT-2 programmable logic controllers while installed in conductive shielded control boxes. Please secure the control box lid to the control box (for conduction). Installation within a control box greatly affects the safety of the system and aids in shielding noise from the programmable logic controller.

Caution for Analog Products in use

The analog special adapters have been found to be compliant to the European standards in the aforesaid manual and directive. However, for the very best performance from what are in fact delicate measuring and controlled output device Mitsubishi Electric would like to make the following points;

As analog devices are sensitive by nature, their use should be considered carefully. For users of proprietary cables (integral with sensors or actuators), these users should follow the manufacturers' installation requirements. Mitsubishi Electric recommends that shielded cables be used. If no other EMC protection is provided, then users may experience temporary loss of accuracy between +10%/-10% in very heavy industrial areas. However, Mitsubishi Electric suggests that when adequate EMC precautions are followed with general good EMC practice for the users complete control system, users should expect normal accuracy as specified in this manual.

- Sensitive analog cables should not be laid next to or bound with high voltage cabling. Where possible, users should run analog cables separately.
- Good cable shielding should be used. When grounding the shield - ensure that no loops are accidentally created.
- When reading analog values, EMC induced errors can be smoothed out by averaging the readings. This can be achieved either through functions on the analog special adapter/block or through the user's program in the FX3UC-32MT-LT-2 main unit.

Associated manuals

FX3UC-32MT-LT-2 PLC (main unit) comes with this document (hardware manual).

For a detailed explanation of the FX3UC Series hardware and information on PLC programming instructions and special extension unit/block, refer to the relevant documents.

| Manual name | Manual No. | Description |
|--|-----------------------------------|---|
| FX3UC Series User's Manual - Hardware Edition | JY997D28701 MODEL CODE: 09R519 | Explains the FX3UC Series PLC specifications for I/O, wiring, installation, and maintenance. |
| FX3U/FX3UC Series Programming Manual - Basic & Applied Instruction Edition | JY997D16601 MODEL CODE: 09R517 | Describes PLC programming for basic/applied instructions STL/SFC programming and system devices. |
| FX Series User's Manual - Data Communication Edition | JY997D16901 MODEL CODE: 09R715 | Explains N:N Network, parallel link, computer link, non-protocol communication by RS instructions/FX2N-232IF. |
| FX3U / FX3UC Series User's Manual - Analog Control Edition | JY997D16701 MODEL CODE: 09R619 | Describes specifications for analog control and programming methods for the FX3U / FX3UC Series PLC. |

1. Outline

1.1 Part names

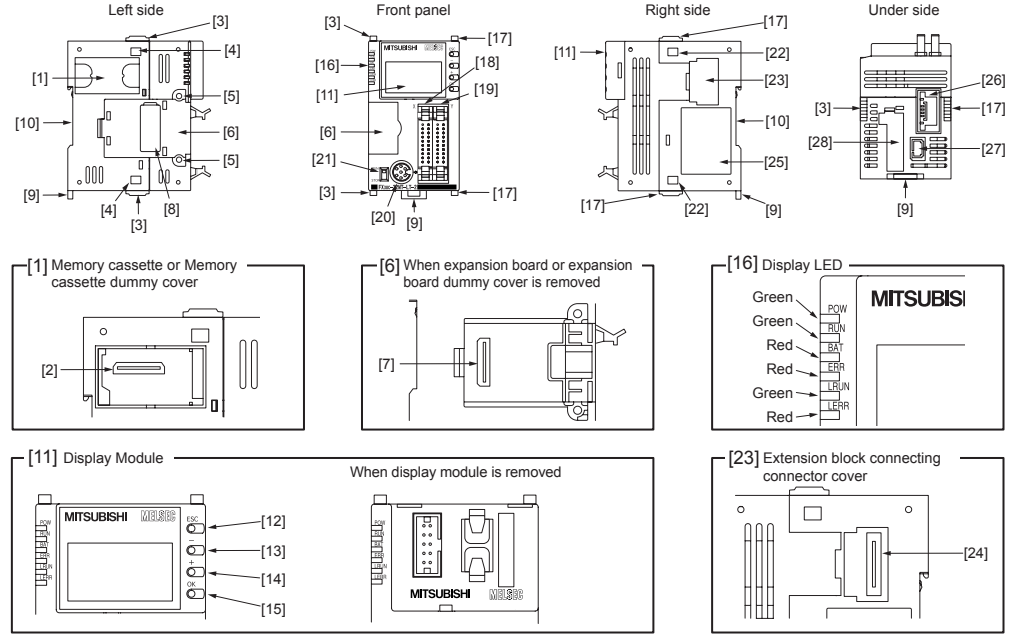

| No. | Name |
|------|--|
| [1] | Memory cassette dummy cover |
| [2] | Memory cassette connecting connector |
| [3] | Special adapter connecting hooks |
| [4] | Special adapter connecting holes |
| [5] | Expansion board fixing holes |
| [6] | Expansion board dummy cover |
| [7] | Expansion board connecting connector |
| [8] | Special adapter connector cover Connectors are not provided when expansion board is not used. |
| [9] | DIN rail mounting hooks |
| [10] | DIN rail mounting groove [DIN rail:DIN46277(35mm(1.38")wide)] |
| [11] | Display Module |
| [12] | "ESC" button |
| [13] | "-" button |
| [14] | "+" button |
| [15] | "OK" button |

| No. | Name | |
|------|--|--|
| [16] | POW LED | On while power to the PLC is on. |
| | RUN LED | On while the PLC is running. |
| | BAT LED | Lights when the battery voltage drops. |
| | ERR LED | Flashing when a program error occurs. Lights when a CPU error occurs. |
| | L RUN LED | On while data link being executed (CC-link/LT built-in master). |
| | L ERR LED | On while data link being error (CC-link/LT built-in master). |
| [17] | FX3UC, FX2NC Extension block connecting hooks | |
| [18] | Input connector | |
| [19] | Output connector | |
| [20] | Peripheral device connector (RS-422) | |
| [21] | RUN/STOP switch | |
| [22] | FX3UC, FX2NC Extension block connecting holes | |
| [23] | FX3UC, FX2NC Extension block connector cover | |
| [24] | FX3UC, FX2NC Extension block connector | |
| [25] | Nameplate | |
| [26] | CC-Link/LT interface connector | |
| [27] | Power connector for main unit | |
| [28] | Battery cover, FX3U-32BL type battery (supplied) | |

| Manual name | Manual No. | Description |
|---|-----------------------------------|---|
| FX3U / FX3UC Series User's Manual - Positioning Control Edition | JY997D16801 MODEL CODE: 09R620 | Explains the positioning control specifications of the FX3U / FX3UC Series and programming procedures |

How to obtain manuals

For product manuals or documents, consult with the Mitsubishi Electric dealer from who you purchased your product.

Incorporated Items

Verify that the following product and items are included in the package.

| | | Included Items |
|---------------------------------|---|----------------|
| FX3UC-32MT-LT-2 | Product | 1 unit |
| | FX2NC-100MPCB [1m (3' 3"), three wire] | 1 cable |
| | FX2NC-100BPCB [1m (3' 3"), two wire] | 1 cable |
| | Manuals (Japanese version, English version) | 1 manual each |
| Input / output extension blocks | | |
| FX2NC-□□EX FX2NC-16EX-T | Product | 1 unit |
| | FX2NC-10BPCB1 [0.1m (3.93"), double-ended] | 1 cable |
| FX2NC-□□EYT FX2NC-16EYR-T | Product | 1 unit |

1.2 External dimensions/weight

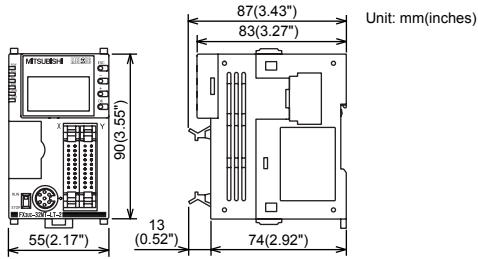

FX2NC input/output extension blocks (Connector type)

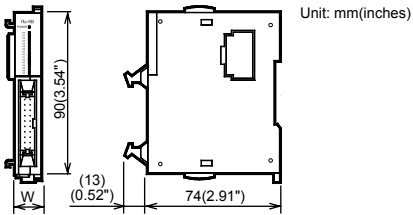

FX2NC input/output extension blocks (Terminal block type)

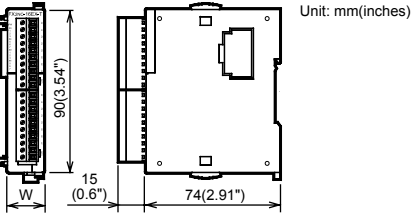

| Type | Model name | W:mm (inches) | MASS (Weight): kg (lbs) |
|---|-----------------|---------------|-------------------------|
| Main unit | FX3UC-32MT-LT-2 | 55.0 (2.17) | 0.25 (0.55) |
| Input/output extension blocks (Connector type) | FX2NC-16EX | 14.6 (0.57) | 0.15 (0.33) |
| | FX2NC-32EX | 26.2 (1.03) | 0.20 (0.44) |
| | FX2NC-16EYT | 14.6 (0.57) | 0.15 (0.33) |
| Input/output extension blocks (Terminal block type) | FX2NC-32EYT | 26.2 (1.03) | 0.20 (0.44) |
| | FX2NC-16EX-T | 20.2 (0.57) | 0.15 (0.33) |
| | FX2NC-16EYR-T | 24.2 (0.95) | 0.20 (0.44) |

1.3 Difference with FX3uc-32MT-LT

The FX3UC-32MT-LT-2 differs from the FX3UC-32MT-LT regarding the following point.

- The FX3UC-32MT-LT-2 has no Dip switches for setting the built-in CCLink/LT master function CC-Link/LT is set up with GX Developer (Ver.8.68W or later) or a display module.

2. General specifications and Installation

As for installation of the input/output extension blocks, special adapters and expansion boards, refer to FX3UC Series User's Manual - Hardware Edition.

INSTALLATION PRECAUTIONS **⚠ DANGER**

- Make sure to cut off all phases of the power supply externally before attempting installation or wiring work. Failure to do so may cause electric shock or damage to the product.

INSTALLATION PRECAUTIONS **⚠ CAUTION**

- Use the product within the generic environment specifications described in section 2.1 of this manual. Never use the product in areas with excessive dust, oily smoke, conductive dusts, corrosive gas (salt air, Cl₂, H₂S, SO₂ or NO₂), flammable gas, vibration or impacts, or expose it to high temperature, condensation, or rain and wind. If the product is used in such conditions, electric shock, fire, malfunctions, deterioration or damage may occur.
- Do not touch the conductive parts of the product directly. Doing so may cause device failures or malfunctions.
- Install the product securely using a DIN rail.
- Install the product on a flat surface. If the mounting surface is rough, undue force will be applied to the PC board, thereby causing nonconformities.
- Connect the extension cables, peripheral device cables, input/output cables and battery connecting cable securely to their designated connectors. Unsecured connection may cause malfunctions.
- Turn off the power before attaching or detaching the following devices. Failure to do so may cause device failures or malfunctions.
 - Peripheral devices, display module, expansion boards.
 - Extension blocks, connector conversion adapter, extension power supply units, special adapters, and FX Series terminal blocks.
 - Battery and memory cassettes

Notes

- When a dust proof sheet is supplied with an extension unit/block, keep the sheet applied to the ventilation slits during installation and wiring work.
- To prevent temperature rise, do not install the PLC on a floor, a ceiling or a vertical surface. Install it horizontally on a wall as shown in section 2.2.
- Keep a space of 50mm (1.97") or more between the unit main body and another device or structure (section 2.2 part A). Install the unit as far away as possible from high-voltage lines, high-voltage devices and power equipment.

WIRING PRECAUTIONS **⚠ DANGER**

- Make sure to cut off all phases of the power supply externally before attempting installation or wiring work. Failure to do so may cause electric shock or damage to the product.

WIRING PRECAUTIONS **⚠ CAUTION**

- Connect the DC power supply wiring to the dedicated connectors specified in this manual. If an AC power supply is connected to a DC input/output terminal(connector) or DC power supply terminal(connector), the PLC will burn out.
- Do not wire vacant terminals externally. Doing so may damage the product.
- Perform class D grounding (grounding resistance: 100Ω or less) to the grounding terminal on the main unit. Do not use common grounding with heavy electrical systems (refer to subsection 3.1.3).
- When drilling screw holes or wiring, make sure cutting or wire debris does not enter the ventilation slits. Failure to do so may cause fire, equipment failures or malfunctions.

Notes

- Input/output wiring 50 to 100m (164'1" to 328'1") long will cause almost no problems of noise, but, generally, the wiring length should be less than 20m (65'7") to ensure the safety.
- Extension cables are easily affected by noise. Lay the cables at a distance of at least 30 to 50mm (1.19" to 1.97") away from the PLC output and other power lines.

2.1 Generic specifications [Main unit]

| Item | Specification | | | |
|------------------------------|--|--|-----------------------------------|----------------------|
| Ambient temperature | 0 to 55°C (32 to 131°F) when operating and -25 to 75°C (-13 to 167°F) when stored | | | |
| Ambient humidity | 5 to 95%RH (no condensation) when operating | | | |
| Vibration resistance | When installed on DIN rail | Fre-quency (Hz) | Acceler-ation (m/s ²) | Half ampli-tude (mm) |
| | | 10 to 57 | - | 0.035 |
| | | 57 to 150 | 4.9 | - |
| | Sweep Count for X, Y, Z: 10 times (80 min. in each direction) | | | |
| Shock resistance | 147m/s ² Acceleration, Action time: 11ms, 3 times by half-sine pulse in each direction X, Y, and Z | | | |
| Noise resistance | By noise simulator at noise voltage of 1,000Vp-p, noise width of 1μs, rise time of 1ns and period of 30 to 100Hz | | | |
| Dielectric withstand voltage | 500V AC for one minute | Comply with JEM-1021 • Between batch of all terminals and ground terminal | | |
| Insulation resistance | 5MΩ or more by 500V DC megger | | | |
| Grounding | Class D grounding (grounding resistance: 100Ω or less) <Common grounding with a heavy electrical system is not allowed.> ^{*1} | | | |
| Working atmosphere | Free from corrosive or flammable gas and excessive conductive dusts | | | |
| Working altitude | <2000m ^{*2} | | | |

*1 For common grounding, refer to section 3.1.3.

*2 The PLC cannot be used at a pressure higher than the atmospheric pressure to avoid damage.

2.2 Installation location

Install the PLC in an environment conforming to the generic specifications (section 2.1), installation precautions and notes. For more details, refer to FX3UC Series User's Manual - Hardware Edition.

Installation location in enclosure

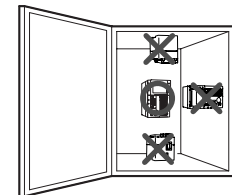

Space in enclosure

Extension devices can be connected on the left and right sides of the PLC main unit. If you intend to add extension devices in the future, keep extra space on the left and right sides open.

Configuration without extension cable

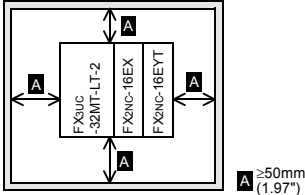

Configuration with extension cable

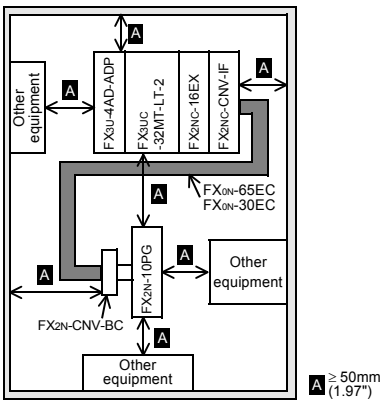

2.3 Procedures for installing to and detaching from DIN rail

The main unit can be installed on a DIN46277 rail [35mm (1.38") wide].
(It cannot be installed directly with screws.)

2.3.1 Installing methods

- 1) Turn the power supply OFF.
- 2) Push the DIN rail mounting hooks ① of all connected units/blocks as shown in the figure on the right ②.

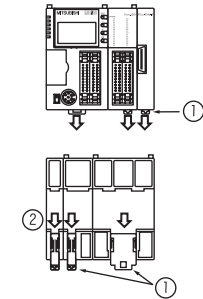

- 3) Align the upper side of the DIN rail mounting groove with the DIN rail (③ in the figure on the right).

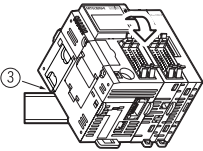

- 4) While pressing the main unit onto the DIN rail, lock the DIN rail mounting hooks as shown in the figure below ④.

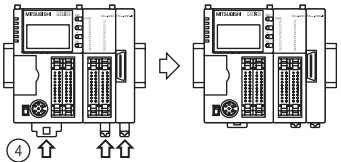

2.3.2 Removal methods

- 1) Turn the power supply OFF.
- 2) Disconnect all connected cables including the power cable, I/O cable and CC-Link/LT cable.
- 3) Insert a flathead screwdriver to the DIN rail mounting hook (① in the figure on the right).
- 4) Lever the screwdriver slightly toward direction ②, to pull out the DIN rail mounting hooks, allowing them to come off the DIN rail.
- 5) Remove the main unit from the DIN rail (③ in the figure on the right).
- 6) Push the DIN rail mounting hooks as shown in the figure on the right ④.

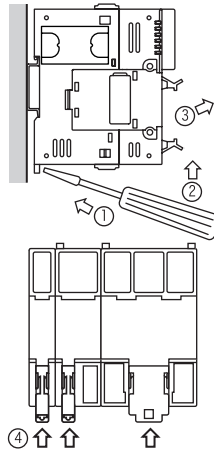

2.4 Display module Installing/Removal

The display module can be removed.

2.4.1 Removal

- 1) Turn the power supply OFF.
- 2) Gently place the tip of a flat head screwdriver to the Display module fixing hooks (fig. ①).
- 3) Tilt the flat head screwdriver at the two Display module fixing hooks to lift the display module from the main unit by about 1 mm (0.04") (right fig. ②). Carefully perform the above trying not to bend or break the Display module fixing hooks.
- 4) Hold the display module (right fig.) and remove the display module.

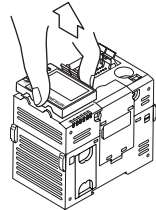
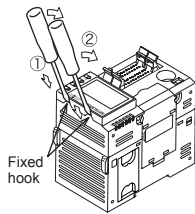

2.4.2 Installing

- 1) Turn the power supply OFF.
- 2) Put the connector of the display module on the main unit (figure on the right).
- 3) Push the display module to install it (① in the figure on the right).

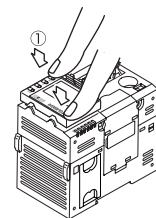

2.5 Connection of power supply connector

Use the dedicated built-in power connector to supply power to the main unit. Power should be supplied to the main unit, FX2NC Series input extension blocks. Perform crossover wiring using two (upper and lower) power connectors for input extension blocks.

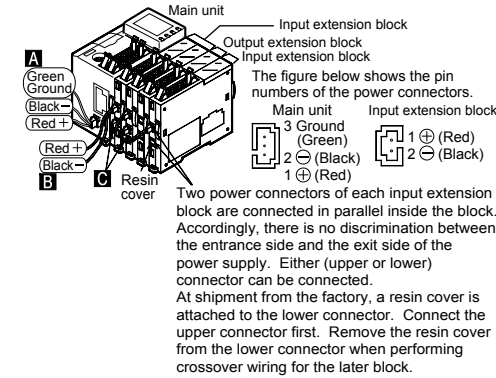

Removal of the power cable

- 1) Turn the power supply OFF.
- 2) Pinch the power cable connector "A" and disconnect it in the direction of the arrow (see figure on the right).

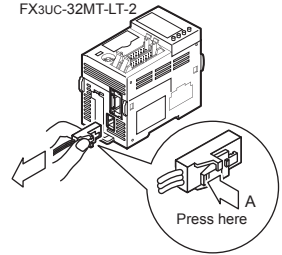

Power Cable types "A" and "B" are supplied with the main unit, while type "C" is supplied with the input extension blocks.

| Type | Application | Model | Length | Cable supplied with |
|------|--|---------------|--------------|-----------------------|
| A | Power cable for main unit | FX2NC-100MPCB | 1m (3' 3") | Main unit |
| B | Input power cable for FX2NC series input extension blocks. | FX2NC-100BPCB | 1m (3' 3") | |
| C | Input power crossover cable for FX2NC series input extension blocks. | FX2NC-10BPCB1 | 0.1m (3.93") | Input extension block |

The crossover cable (type "C") can skip up to 4 16-point output blocks to connect units. If more blocks should be skipped to supply power to an input block, use cable type "B".

<Self-made power cable>

To use self-made power cables, use the following wire and connector suggestions:

| | | |
|----------------------|--|--|
| Wire size | AWG24(0.2mm ²) | |
| Crimp-style terminal | 50083-8014 (manufactured by Molex Japan Co., Ltd.) | |
| Housing | For main unit | 51030-0330 (manufactured by Molex Japan Co., Ltd.) |
| | For input extension block | 51030-0230 (manufactured by Molex Japan Co., Ltd.) |

2.6 Connection to input/output connector

The input/output connectors of the Main units conform to MIL-C-83503.

Refer to Chapter 4 for the I/O connector pin arrangement.

(For CC-Link/LT interface connector, refer to FX3UC Series User's Manual - Hardware Edition.)

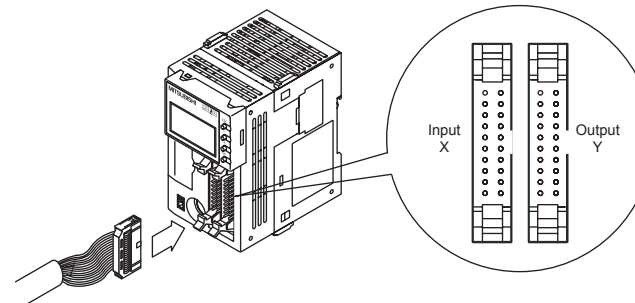

1) Compliant connectors (commercially available connectors)

Use a 20-pin (1-key) socket connector conforming to MIL-C-83503.
Confirm in advance that the connectors do not interfere with other parts including connector covers.

2) Input/output cables (available from Mitsubishi)

Input/output cables with attached connectors are available.

| Model names | Length | Description | Shape |
|-----------------|-----------------|--|---|
| FX-16E-500CAB-S | 5m (16'4") | General-purpose input/output cable | A 20-pin connector is fitted only to one end of bulk wire. (Wire color: red) |
| FX-16E-150CAB | 1.5m (4'11") | Cables for connecting the FX Series terminal block with input/output connectors. For terminal block connection, refer to FX3UC Series User's Manual - Hardware Edition. | Flat cables (with tube) with a 20-pin connector at both ends |
| FX-16E-300CAB | 3m (9'10") | | |
| FX-16E-500CAB | 5m (16'4") | | |
| FX-16E-150CAB-R | 1.5m (4'11") | | |
| FX-16E-300CAB-R | 3m (9'10") | | |
| FX-16E-500CAB-R | 5m (16'4") | | |
| FX-A32E-150CAB | 1.5m (4'11") | | |
| FX-A32E-300CAB | 3m (9'10") | | |
| FX-A32E-500CAB | 5m (16'4") | | |

3) Connectors for user-made input/output cables (available from Mitsubishi)

Users should provide electric wires and a pressure bonding tool.

| Model name and composition of input/output connector | | Applicable electric wire (UL-1061 are recommended) and tool | | |
|--|--------------|---|--|---|
| Our model name | | Details of part (made by DDK Ltd.) | Electric wire size | Pressure bonding tool (made by DDK Ltd.) |
| FX2c-I/O-CON for flat cable | 10-piece set | Solderless connector FRC2-A020-30S | AWG28 (0.1mm ²) 1.27 pitch, 20-core | 357J-4674D:Main body 357J-4664N:Attachment |
| FX2c-I/O-CON-S for bulk wire | 5-piece set | Housing HU-200S2-001 Solderless contact HU-411S | AWG22 (0.3mm ²) | 357J-5538 |
| FX2c-I/O-CON-SA for bulk wire | 5-piece set | Housing HU-200S2-001 Solderless contact HU-411SA | AWG20 (0.5mm ²) | 357J-13963 |

4) Certified connectors (commercially available connectors)

Connectors made by DDK Ltd. shown in item (3) described in the previous page and connectors made by Matsushita Electric Works, Ltd. shown in the following table.

| Model name of connector | | Compliant electric wires (UL-1061 is recommended) | Pressure bonding tool |
|-------------------------|-----------|--|-----------------------|
| Housing | AXW1204A | AWG22(0.3mm ²), AWG24(0.2mm ²) | AXY52000 |
| Contact | AXW7221 | | |
| Semi-cover | AXW62001A | | |

3. Power supply/input/output specifications and examples of external wiring

DESIGN PRECAUTIONS

- Make sure to have the following safety circuits outside of the PLC to ensure safe system operation even during external power supply problems or PLC failure. Otherwise, malfunctions may cause serious accidents.
 - Most importantly, have the following: an emergency stop circuit, a protection circuit, an interlock circuit for opposite movements (such as normal vs. reverse rotation), and an interlock circuit (to prevent damage to the equipment at the upper and lower positioning limits).
 - Note that when the PLC CPU detects an error, such as a watchdog timer error, during self-diagnosis, all outputs are turned off. Also, when an error that cannot be detected by the PLC CPU occurs in an input/output control block, output control may be disabled. External circuits and mechanisms should be designed to ensure safe machinery operation in such a case.
 - Note that when an error occurs in a relay, triac or transistor output device, the output could be held either on or off. For output signals that may lead to serious accidents, external circuits and mechanisms should be designed to ensure safe machinery operation in such a case.
- Note that when an error occurs in a remote I/O unit, the output could be held either on or off. For output signals that may lead to serious accidents, external circuits for monitoring should be provided.

DESIGN PRECAUTIONS

- Do not bundle the control line and CC-Link/LT connection cables together with or lay them close to the main circuit or power line. As a guideline, lay the control line and CC-Link/LT connection cables at least 100 mm (3.94") or more away from the main circuit or power line. Noise may cause malfunctions.
- Install the product so that excessive force will not be applied to peripheral device connectors, power connectors, input/output connectors, CC-Link/LT interface connectors or CC-Link/LT connection cables. Failure to do so may result in wire damage/breakage or PLC failure.

Notes

- Simultaneously turn on and off the power supplies of the main unit and extension devices.
- Even if the power supply causes an instantaneous power failure for less than 5ms, the PLC can continue to operate.
- If a long-time power failure or an abnormal voltage drop occurs, the PLC stops, and output is turned off. When the power supply is restored, it will automatically restart (when the RUN input is on).

WIRING PRECAUTIONS

- Make sure to cut off all phases of the power supply externally before attempting installation or wiring work. Failure to do so may cause electric shock or damage to the product.

WIRING PRECAUTIONS

- Connect the DC power supply wiring to the dedicated connectors specified in this manual. If an AC power supply is connected to a DC input/output terminal(connector) or DC power supply terminal(connector), the PLC will burn out.
- Do not wire vacant terminals externally. Doing so may damage the product.
- Perform class D grounding (grounding resistance: 100Ω or less) to the grounding terminal on the main unit. Do not use common grounding with heavy electrical systems (refer to section 3.2).
- When drilling screw holes or wiring, make sure cutting or wire debris does not enter the ventilation slits. Failure to do so may cause fire, equipment failures or malfunctions.

Notes

- Input/output wiring 50 to 100m (164'1" to 328'1") long will cause almost no problems of noise, but, generally, the wiring length should be less than 20m (65'7") to ensure the safety.
- Extension cables are easily affected by noise. Lay the cables at a distance of at least 30 to 50mm (1.19" to 1.97") away from the PLC output and other power lines.

3.1 Power supply specifications and example of external wiring

For more details, refer to FX3UC Series User's Manual - Hardware Edition.

3.1.1 Power supply specifications

The specifications for the power supply of the main unit are shown in the following table.

| Item | Specification | |
|--|---|------------|
| Supply voltage | 24V DC +20% -15%*1 Ripple Voltage (p-p)5% or less | |
| Allowable instantaneous power failure time | Operation can be continued upon occurrence of an instantaneous power failure for 5ms or less. | |
| Power fuse | CPU, I/O operations power supply circuit | 125V 3.15A |
| | CC-Link/LT built-in power supply circuit | 125V 0.8A |
| Rush current | 30A max.0.5ms/24V DC | |
| Power consumption *2 | 9W | |
| 5V DC built-in power supply*3 | 5V DC, 350mA | |
| Built-in power supply for CC-Link/ LT networks | 24V DC, 350mA | |

*1 When the built-in CC-Link/LT master function is used, refer to the FX3UC Series User's Manual - Hardware Edition.

*2 Input/output extension blocks, special function units/blocks and CC-Link/LT network are not contained in power consumption. For power consumption of the FX2NC input/output extension blocks, refer to the following table. Refer to the FX3UC Series User's Manual - Hardware Edition. For the power consumed by the special function units/blocks, refer to the appropriate manuals.

| Model names | Power consumption |
|---------------|-------------------|
| FX2NC-16EX-T | 2.2W |
| FX2NC-16EX | 2.2W |
| FX2NC-32EX | 4.2W |
| FX2NC-16EYR-T | 2.2W |
| FX2NC-16EYT | 0.35W |
| FX2NC-32EYT | 0.7W |

*3 Cannot be used to supply power to an external destination. This power is supplied to input/output extension blocks, special extension blocks, special adapters and expansion boards only.

3.1.2 Example of external wiring (power type)

Supply 24V DC power to the main unit and FX2NC-□□EX(-T) using the dedicated connector. For the details of wiring work, refer to Section 2.5. For the power supply wiring of the FX2NC input extension blocks, refer to the Subsection 3.2.3

Use a 24V DC +20% -15%¹ DC power supply whose ripple (p-p) is within 5%. The allowable range of the 24V DC power supply may be narrower when special function units/blocks are connected. For more details, refer to the FX3UC Series User's Manual - Hardware Edition

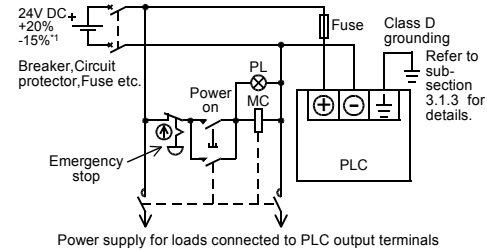

*1 When the built-in CC-Link/LT master function is used, refer to the FX3UC Series User's Manual - Hardware Edition.

3.1.3 Grounding

Ground the PLC as stated below.

- Perform class D grounding. (Grounding resistance: 100 Ω or less)
- Ground the PLC independently if possible. If it cannot be grounded independently, ground it jointly as shown below.

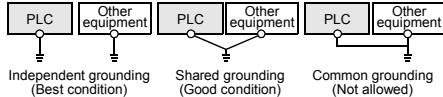

- Position the grounding point as close to the PLC as possible to decrease the length of the ground wire.

3.2 Input specifications and external wiring

For more details, refer to the FX3UC Series User's Manual - Hardware Edition

3.2.1 Input specifications

| Item | Input specification (24V DC) | |
|------------------------------|---|--|
| Number of input points | FX3UC-32MT-LT-2 | 16 points |
| | FX2NC-16EX | 16 points |
| | FX2NC-32EX | 32 points |
| | FX2NC-16EX-T | 16 points |
| Input connecting type | FX3UC-32MT-LT-2 FX2NC-□□EX | connector |
| | FX2NC-16EX-T | Terminal block |
| | | |
| Input signal voltage | 24V DC +20% -15% Ripple Voltage (p-p)5% or less | |
| Input impedance | X000 to X005 | 3.9kΩ |
| | X006, X007 | 3.3kΩ |
| | X010 to X017, Input extension block | 4.3kΩ |
| | | |
| Input signal current | X000 to X005 | 6mA/24V DC |
| | X006, X007 | 7mA/24V DC |
| | X010 to X017, Input extension block | 5mA/24V DC |
| ON input sensitivity current | X000 to X005 | 3.5mA or more |
| | X006, X007 | 4.5mA or more |
| | X010 to X017, Input extension block | 3.5mA or more |
| Input OFF current | 1.5mA or less | |
| Input response time | Approx. 10ms ^{*2} | |
| Input signal form | No-voltage contact input NPN open collector transistor | |
| Circuit insulation | Photocoupler insulation | |
| Operation display | FX3UC-32MT-LT-2 | Monitor by the display module |
| | Input extension block | LED on panel turns ON when photocoupler is driven. |

*1 X000 to X017 use adjustable digital filter values. For details, refer to subsection 3.2.2.

3.2.2 Handling of 24V DC input

Input terminals:

Inputs turn ON when the input terminal and COM terminal are electrically connected with a no-voltage contact or NPN open collector transistor

Input circuit:

The primary and secondary circuits for input are insulated with a photocoupler, and the second circuit is provided with a C-R filter. The C-R filter is designed to prevent malfunctions caused by chattering (bouncing) input contacts or noise from the input line.

Accordingly, responses are delayed by approximately 10ms inside the PLC against input status change from ON to OFF or from OFF to ON.

X000 to X017 (Main unit) have digital filters, and the filter time can be changed in increments of 1ms in the range from 0 to 60ms using applied instructions. When 0 is specified for the input filter time, the actual input filter values are set as shown in the following table.

| Input number | Input filter value when 0 is specified |
|--------------|--|
| X000 to X005 | 5μs ^{*1} |
| X006, X007 | 50μs |
| X010 to X017 | 200μs |

*1 When setting the input filter to 5μs or capturing pulses of a 50 to 100kHz response frequency with a high speed counter, wire the terminals as stated below.

- The wiring length should be 5m (16'4") or less.
- Connect a bleeder resistor of 1.5kΩ (1W or more) to the input terminal, so that the sum of the load current of the open collector transistor output on the connected device and the input current of the main body is 20mA or more.

3.2.3 Example of input wiring

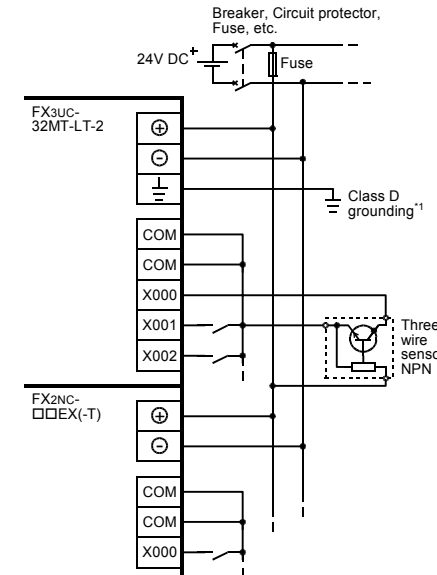

*1 The grounding resistance should be 100Ω or less.

3.2.4 Instructions for input devices

The input current of this PLC is 5 to 7mA/24V DC. Use input devices applicable to this minute current. If switches for larger current are being used, contact failure may occur.

<Example> Products of OMRON

| Type | Model name | Type | Model name |
|------------------|----------------------|----------------------|------------|
| Microswitch | Models Z, V and D2RV | Operation switch | Model A3P |
| Proximity switch | Model TL | Photoelectric switch | Model E3S |

- In the case of input devices with built-in series diodes:**
The voltage drop of the series diode should be approx. 4V or less. When lead switches with a series LED are used, up to two switches can be connected in series. Also make sure that the input current is over the input-sensing level while the switches are ON.

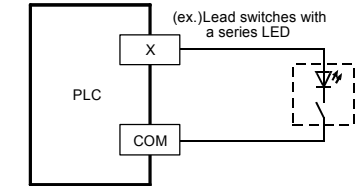

- In the case of input device with built-in parallel resistance:**
Use a device with a parallel resistance, Rp, of 15kΩ or more. When the resistance is less than 15kΩ, connect a bleeder resistor, Rb, obtained from the formula as shown in the following figure.

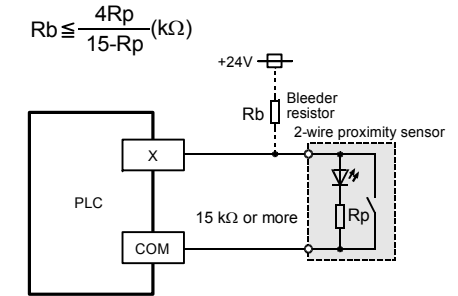

- In the case of 2-wire proximity switch:**

Use a two-wire proximity switch whose leakage current, I_l, is 1.5mA or less when the switch is off. When the current is 1.5mA or more, connect a bleeder resistor, Rb, obtained from formula as shown in the following figure.

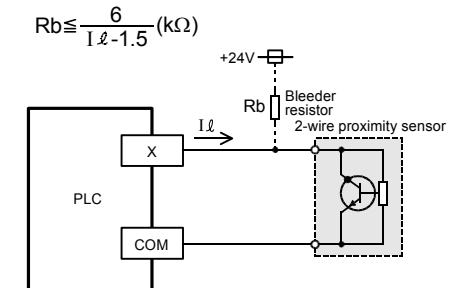

3.3 Output specifications and example of external wiring

For more details, refer to the FX3UC Series User's Manual - Hardware Edition

3.3.1 Transistor output specifications

| Item | | Output specification (Transistor) | | | |
|------------------------------|-------------------------|--|---|---|--|
| Number of output points | FX3UC-32MT-LT-2 | 16 points | | | |
| | FX2NC-16EYT | 16 points | | | |
| | FX2NC-32EYT | 32 points | | | |
| Output connecting type | connector | | | | |
| External power supply | 5 to 30V DC | | | | |
| Max. load | Resistance load | FX3UC-32MT-LT-2 | Y000 to Y003 | 0.3A/point | Make sure that the total load current of 8 resistance load points is 0.8A ^{*1} or less. |
| | | | Y004 to Y017 | 0.1A/point | |
| | | FX2NC-□□EYT | | 0.1A/point | |
| | Inductive load | FX3UC-32MT-LT-2 | Y000 to Y003 | 7.2W/point (24V DC) | Make sure that the total load of 16 inductive load points is 38.4W/24V DC or less. |
| | | | Y004 to Y017 | 2.4W/point (24V DC) | |
| | | FX2NC-□□EYT | | 2.4W/point (24V DC) | |
| Open circuit leakage current | 0.1mA or less/30V DC | | | | |
| Response time | OFF→ON | FX3UC-32MT-LT-2 | Y000 to Y003 | 5μs or less/10mA or more (5 to 24V DC) ^{*2} | Photocoupler insulation |
| | | | Y004 to Y017 | 0.2ms or less/100mA or more (at 24V DC) ^{*3} | |
| | | FX2NC-□□EYT | | 0.2ms or less/100mA or more (at 24V DC) | |
| | ON→OFF | FX3UC-32MT-LT-2 | Y000 to Y003 | 5μs or less/10mA or more (5 to 24V DC) ^{*2} | |
| | | Y004 to Y017 | 0.2ms or less/100mA or more (at 24V DC) ^{*3} | | |
| | FX2NC-□□EYT | | 0.2ms or less/100mA or more (at 24V DC) | | |
| Circuit insulation | Photocoupler insulation | | | | |
| Display of output operation | FX3UC-32MT-LT-2 | Monitor by the display module | | | |
| | FX2NC-□□EYT | LED on panel turns ON when photocoupler is driven. | | | |

1 When the two COM terminals are connected outside the PLC, resistance load is 1.6A or less. Where * indicates:1 or 2

*2 When using an instruction related to pulse train output or positioning, make sure to set the load current to 10 to 100mA (5 to 24V DC).

*3 The transistor OFF time is longer under lighter loads. For example, under a load of 24V DC 40mA, the response time is approx. 0.3ms. When response performance is required under light loads, provide a dummy resistor to increase the load current.

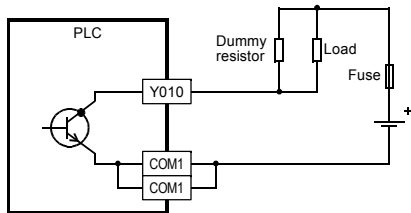

3.3.2 Handling of transistor output circuit

Output terminal:

The main unit and FX2NC input/output extension block have 16 transistor output points per common. Two COM* terminals connected to each other inside the PLC are provided for outputs. Connect two COM* terminals outside the PLC so that the load applied to each COM* terminal is smaller. Where * indicates:1 or 2

Output current

The ON voltage of the output transistor is approx. 1.5V. When driving a semiconductor element, carefully check the input voltage characteristics of the applied element.

3.3.3 Example of transistor output wiring

1. Examples of sink output wiring

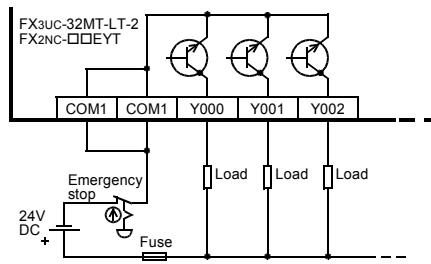

3.3.4 Cautions on transistor output wiring

For more details, refer to FX3UC Series User's Manual - Hardware Edition

1) Protection circuit for load short-circuits

A short-circuit at a load connected to an output terminal could cause burnout at the output element or the PC board. To prevent this, a protection fuse should be included at the output. Use a load power supply capacity that is two times or more the total rated capacity of the fuses connected to the load circuit.

2) Contact protection circuit for inductive loads

When an inductive load is connected, connect a diode (for commutation) in parallel with the load as necessary. The diode (for commutation) must comply with the following specifications.

| | |
|-----------------|-----------------------------------|
| Reverse voltage | 5 to 10 times of the load voltage |
| Forward current | Load current or more |

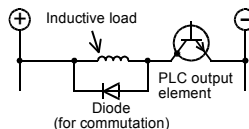

3) Interlock

Loads, such as contactors for normal and reverse rotations, that must not be turned on simultaneously should have an interlock in the PLC program and an external interlock as shown below.

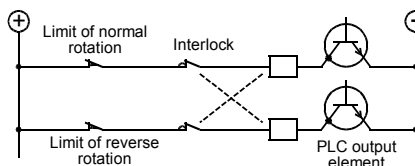

3.3.5 Relay output specifications

| Item | | Output specification (Relay) | |
|------------------------------|--|------------------------------|--|
| Number of output points | FX2NC-16EYR-T | 16 points | |
| Output connecting type | Terminal block | | |
| External power supply | 30V DC or less or 240V AC or less (250V AC or less when the unit does not comply with CE, UL or cUL standards) | | |
| Max. load | Resistance load | 2A/point | When using one COM□ terminal, make sure that the total load current of 8 resistance load points is 4 A or less. When connecting two COM□ terminals outside the PLC, make sure that the total load current of 8 resistance load points is 8A or less. |
| | Inductive load | 80VA | For the product life of relay contacts, refer to the FX3UC Series User's Manual - Hardware Edition. |
| Open circuit leakage current | - | | |
| Minimum load | 5V DC, 2 mA (reference value) | | |
| Response time | OFF→ON | Approx. 10 ms | |
| | ON→OFF | Approx. 10 ms | |
| Circuit insulation | Mechanical insulation | | |
| Display of output operation | LED on panel lights when power is applied to relay coil. | | |

3.3.6 Handling of relay output circuit

Output terminal:

The FX2NC-16EYR-T has 8 relay output points per common. Two COM* terminals connected to each other inside the PLC are provided for outputs. Connect two COM* terminals outside the PLC so that the load applied to each COM* terminal is smaller. Where * indicates:1 or 2

3.3.7 Example of relay output wiring

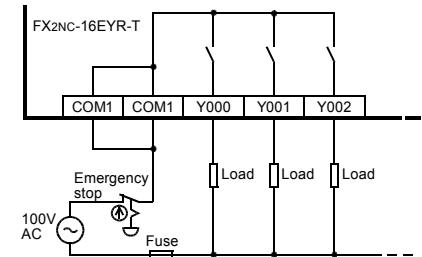

3.3.8 Cautions on relay output wiring

For more details, refer to FX3UC Series User's Manual - Hardware Edition

1) Protection circuit for load short-circuits

A short-circuit at a load connected to an output terminal could cause burnout at the output element or the PC board. To prevent this, a protection fuse should be included at the output.

2) Protection circuit of contact when inductive load is used

An internal protection circuit for the relays is not provided for the relay output circuit in the extension block. It is recommended to use inductive loads with built-in protection circuits. When using loads without built-in protection circuits, insert an external contact protection circuit, etc. to reduce noise and extend the product life.

a) DC circuit

Connect a diode in parallel with the load. Use a diode (for commutation) having the following specifications.

| | |
|-----------------|-----------------------------------|
| Reverse voltage | 5 to 10 times of the load voltage |
| Forward current | Load current or more |

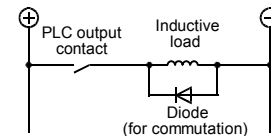

b) AC circuit
 Connect the surge absorber (combined CR components such as a surge killer and spark killer, etc.) parallel to the load. Select the rated voltage of the surge absorber suitable to the output used. Refer to the table below for other specifications.

| | |
|------------------------|-----------------------------|
| Electrostatic capacity | Approx. 0.1 μ F |
| Resistance value | Approx. 100 to 200 Ω |

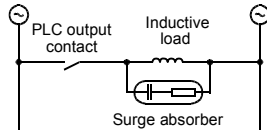

3) Interlock
 Loads, such as contactors for normal and reverse rotations, that must not be turned on simultaneously should have an interlock in the PLC program and an external interlock.

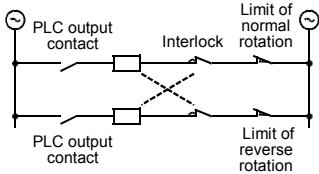

4) Common mode
 Use output contacts of the PLC in the common mode.

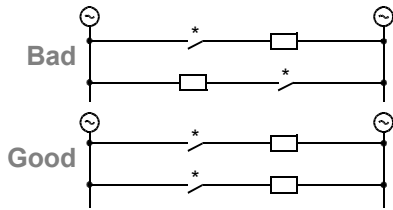

3.3.9 Input/Output Derating Curve

The derating curve below shows the simultaneous ON ratio of available PLC inputs or outputs with respect to the ambient temperature. Use the PLC within the simultaneous input or output ON ratio range shown in the figure.

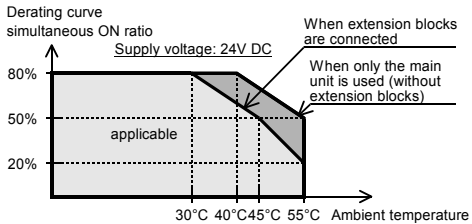

4. Terminal Layout (Input/output connector)

4.1 Main units

4.1.1 FX3UC-32MT-LT-2

FX3UC-32MT-LT-2

| | | | |
|-----|-----|------|------|
| IN | | OUT | |
| X0 | X10 | Y0 | Y10 |
| X1 | X11 | Y1 | Y11 |
| X2 | X12 | Y2 | Y12 |
| X3 | X13 | Y3 | Y13 |
| X4 | X14 | Y4 | Y14 |
| X5 | X15 | Y5 | Y15 |
| X6 | X16 | Y6 | Y16 |
| X7 | X17 | Y7 | Y17 |
| COM | COM | COM1 | COM1 |
| • | • | • | • |

4.2 FX2nc input/output extension blocks

4.2.1 FX2NC-□□EX

FX2NC-16EX

| | |
|-----|-----|
| IN | |
| X0 | X0 |
| X1 | X1 |
| X2 | X2 |
| X3 | X3 |
| X4 | X4 |
| X5 | X5 |
| X6 | X6 |
| X7 | X7 |
| COM | COM |
| • | • |

FX2NC-32EX

| | | | |
|-----|-----|-----|-----|
| IN | | IN | |
| X0 | X0 | X0 | X0 |
| X1 | X1 | X1 | X1 |
| X2 | X2 | X2 | X2 |
| X3 | X3 | X3 | X3 |
| X4 | X4 | X4 | X4 |
| X5 | X5 | X5 | X5 |
| X6 | X6 | X6 | X6 |
| X7 | X7 | X7 | X7 |
| COM | COM | COM | COM |
| • | • | • | • |

4.2.2 FX2NC-□□EYT

FX2NC-16EYT

| | |
|------|------|
| OUT | |
| Y0 | Y0 |
| Y1 | Y1 |
| Y2 | Y2 |
| Y3 | Y3 |
| Y4 | Y4 |
| Y5 | Y5 |
| Y6 | Y6 |
| Y7 | Y7 |
| COM1 | COM1 |
| • | • |

FX2NC-32EYT

| | | | |
|------|------|------|------|
| OUT | | OUT | |
| Y0 | Y0 | Y0 | Y0 |
| Y1 | Y1 | Y1 | Y1 |
| Y2 | Y2 | Y2 | Y2 |
| Y3 | Y3 | Y3 | Y3 |
| Y4 | Y4 | Y4 | Y4 |
| Y5 | Y5 | Y5 | Y5 |
| Y6 | Y6 | Y6 | Y6 |
| Y7 | Y7 | Y7 | Y7 |
| COM1 | COM1 | COM2 | COM2 |
| • | • | • | • |

4.2.3 FX2NC-16EX-T, FX2NC-16EYR-T

FX2NC-16EX-T

| | |
|-------|-----|
| Lower | IN |
| | X0 |
| | X1 |
| | X2 |
| | X3 |
| | X4 |
| | X5 |
| | X6 |
| Upper | X7 |
| | COM |
| | COM |
| | COM |

FX2NC-16EYR-T

| | |
|-------|------|
| Lower | OUT |
| | Y0 |
| | Y1 |
| | Y2 |
| | Y3 |
| | Y4 |
| | Y5 |
| | Y6 |
| Upper | Y7 |
| | COM1 |
| | COM1 |
| | COM1 |

This manual confers no industrial property rights or any rights of any other kind, nor does it confer any patent licenses. Mitsubishi Electric Corporation cannot be held responsible for any problems involving industrial property rights which may occur as a result of using the contents noted in this manual.

Warranty
 Mitsubishi will not be held liable for damage caused by factors found not to be the cause of Mitsubishi; opportunity loss or lost profits caused by faults in the Mitsubishi products; damage, secondary damage, accident compensation caused by special factors unpredictable by Mitsubishi; damages to products other than Mitsubishi products; and to other duties.

! For safe use

- This product has been manufactured as a general-purpose part for general industries, and has not been designed or manufactured to be incorporated in a device or system used in purposes related to human life.
- Before using the product for special purposes such as nuclear power, electric power, aerospace, medicine or passenger movement vehicles, consult with Mitsubishi Electric.
- This product has been manufactured under strict quality control. However, when installing the product where major accidents or losses could occur if the product fails, install appropriate backup or failsafe functions in the system.