



**mitsubishi
ELECTRIC**

Mitsubishi Safety Programmable Controller

MELSEC **QS** series

CC-Link Safety System Remote I/O Module

User's Manual
(Hardware)

QS0J65BTS2-8D

Thank you for purchasing the Mitsubishi safety programmable controller MELSEC-QS series. The MELSEC-QS programmable controller is suitable for establishing safety functions for general industrial machinery.

Prior to use, please read both this manual and detailed manual thoroughly and familiarize yourself with the product.





MODEL	QS0J65BTS2-8D-U-HW
MODEL CODE	13JY66
IB(NA)-0800414-G(1406)MEE	

● SAFETY PRECAUTIONS ●

(Always read these instructions before using this equipment.)

Before using the product, please read this manual, the relevant manuals introduced in this manual, standard programmable controller manuals, and the safety standards carefully and pay full attention to safety to handle the product correctly.

In this manual, the safety instructions are ranked as "  WARNING" and "  CAUTION".

WARNING

Indicates that incorrect handling may cause hazardous conditions, resulting in death or severe injury.

CAUTION

Indicates that incorrect handling may cause hazardous conditions, resulting in minor or moderate injury or property damage.

Note that the  CAUTION level may lead to a serious consequence according to the circumstances.

Always follow the instructions of both levels because they are important to personal safety.

Please save this manual to make it accessible when required and always forward it to the end user.

[Design Precautions]

WARNING

- When a safety programmable controller detects an error in an external power supply or a failure in programmable controller main module, it turns off all the outputs.
Create an external circuit to securely stop the power of hazard by turning off the outputs. Incorrect configuration may result in an accident.
- Create short current protection for a safety relay, and a protection circuit such as a fuse, and breaker, outside a safety programmable controller.
- If load current more than the rating or overcurrent due to a short circuit in the load has flowed in the CC-Link Safety remote I/O module, the module defines it as a fault and turns off all the outputs.
However, if overcurrent flows in the CC-Link Safety remote I/O module for a long time, it may cause smoke or a fire. To prevent it, create a safety circuit such as a fuse outside the module.
- When a safety remote I/O module has detected CC-Link Safety error, it turns off all the outputs.
Note that the outputs in a sequence program are not automatically turned off. If CC-Link Safety error has been detected, create a sequence program that turns off the outputs in the program.
If the CC-Link Safety is restored with the outputs on, it may suddenly operate and result in an accident.
- To inhibit restart without manual operation after safety functions was performed and outputs were turned OFF, create an interlock program which uses a reset button for restart.

CAUTION

- Do not bunch the wires of external devices or communication cables together with the main circuit or power lines, or install them close to each other. They should be installed 100 mm (3.94 inch) or more from each other. Not doing so could result in noise that would cause malfunctions.
- Select the external devices to be connected to the CC-Link Safety remote I/O module, considering the maximum inrush current with reference to the CC-Link Safety System Remote I/O Module User's Manual.

[Installation Precautions]

CAUTION

- Use a safety programmable controller in the environment that meets the general specifications described in the QSCPU User's Manual (Hardware Design, Maintenance and Inspection).
Using this programmable controller in an environment outside the range of the general specifications could result in electric shock, fire, erroneous operation, and damage to or deterioration of the product.
- Make sure to fix the CC-Link Safety remote I/O module with a DIN rail or mounting screws and tighten the screws with the specified torque.
If the screws are too loose, it may cause a drop of the screw or module.
Overtightening may cause a drop due to the damage of the screw or module.
- Do not directly touch the module's conductive parts or electronic components.
Touching the conductive parts could cause an operation failure or give damage to the module.

[Wiring Precautions]

WARNING

- Completely turn off the externally supplied power used in the system when placing wiring. Not completely turning off all power could result in electric shock or damage to the product.
- When energizing or operating the module after installation or wiring, be sure to close the attached terminal cover. Not doing so may result in electric shock.

[Wiring Precautions]

CAUTION

- Be sure to ground the FG terminals and LG terminals to the protective ground conductor.
Not doing so could result in electric shock or erroneous operation.
- When wiring in the programmable controller, be sure that it is done correctly by checking the product's rated voltage and the terminal layout.
Connecting a power supply that is different from the rating or incorrectly wiring the product could result in fire or damage.
- Tighten a terminal block mounting screw, terminal screw, and module mounting screw within the specified torque range. If the terminal block mounting screw or terminal screw is too loose, it may cause a short circuit, fire, or malfunctions. If too tight, it may damage the screw and/or the module, resulting in a drop of the screw or module, a short circuit or malfunctions. If the module mounting screw is too loose, it may cause a drop of the screw or module. Overtightening the screw may cause a drop due to the damage of the screw or module.
- Do not install the control lines or communication cables together with the main circuit lines or power cables. Failure to do so may result in malfunction due to noise.
- Be sure there are no foreign substances such as sawdust or wiring debris inside the module.
Such debris could cause fires, damage, or erroneous operation.
- Be sure to fix the communication cables or power cables by ducts or clamps when connecting them to the module.
Failure to do so may cause damage of the module or cables due to a wobble, unintentional shifting, or accidental pull of the cables, or malfunctions due to poor contact of the cable.
- When removing the connected communication cables or power cables, do not pull the cable with grasping the cable part.
Remove the cable connected to the terminal block after loosening the terminal screws.
Pulling the cable connected to a module may result in malfunctions or damage of the module or cable.

[Startup and Maintenance Precautions]

WARNING

- Do not touch the terminals while power is on.
Doing so could cause shock or erroneous operation.
- Turn off all phases of the external supply power used in the system when cleaning the module or retightening the terminal block mounting screws, terminal screws, or module mounting screws.
Not doing so could result in electric shock. Tighten a terminal block mounting screw, terminal screw, and module mounting screw within the specified torque range. If the terminal block mounting screw or terminal screw is too loose, it may cause a short circuit, fire, or malfunctions. If too tight, it may damage the screw and/or the module, resulting in a drop of the screw or module, a short circuit or malfunctions. If the module mounting screw is too loose, it may cause a drop of the screw or module. Overtightening the screw may cause a drop due to the damage of the screw or module.

CAUTION

- Do not disassemble or modify the modules.
Doing so could cause a failure, malfunctions, injury, or fire.
If the product is repaired or remodeled by other than the specified FA centers or us, the warranty is not covered.
- Do not mount/remove the module to/from the base unit or terminal block more than 50 times (IEC61131-2-compliant), after the first use of the product.
Failure to do so may cause module malfunctions.
- Since the module case is made of resin, do not drop or apply any strong impact to the module. Doing so may damage the module.
- Completely turn off the externally supplied power used in the system before mounting or removing the module to/from the panel.
Not doing so could result in damage to the product.

[Disposal Precautions]

CAUTION

- When disposing of this product, treat it as industrial waste.

● PRÉCAUTIONS DE SÉCURITÉ ●

(Toujours lire ces instructions avant utilisation de l'équipement.)

Avant d'utiliser le produit, prière de lire ce manuel et la documentation à laquelle il renvoie, les manuels des automates programmables standard et les normes de sécurité pertinentes, et toujours considérer la sécurité comme de la plus haute importance en manipulant le produit correctement.

Dans ce manuel, les instructions de sécurité sont classées "AVERTISSEMENT" ou "ATTENTION".

AVERTISSEMENT

Attire l'attention sur le fait qu'une négligence peut créer une situation de danger avec risque de mort ou de blessures graves.

ATTENTION

Attire l'attention sur le fait qu'une négligence peut créer une situation de danger avec risque de blessures légères ou de gravité moyennes ou risque de dégâts matériels.

On remarquera que même au niveau ATTENTION, les conséquences peuvent être graves dans certaines circonstances.

Les instructions de ces deux niveaux doivent toujours être respectées car elles concernent la sécurité des personnes.

Prière de lire attentivement ce manuel et veiller à le transmettre à l'utilisateur final qui doit pouvoir s'y référer autant que de besoin.



AVERTISSEMENT

- *Quand l'automate programmable de sécurité détecte une erreur dans une alimentation externe ou une panne de module principal d'automate programmable, il désactive toutes les sorties.
Constituer un circuit externe coupant infailliblement l'alimentation en cas de danger pour désactiver les sorties. Une configuration incorrecte peut être à l'origine d'un accident.*
- *Prévoir, à l'extérieur de l'automate programmable de sécurité, une protection contre les courants de court-circuit pour les relais de sécurité et un circuit de protection avec fusible ou disjoncteur.*
- *Si le courant de charge excède la valeur nominale ou si une surintensité due à un court-circuit à la charge circule dans le module E/S distant de sécurité CC-Link, le module détecte l'anomalie et désactive toutes les sorties.
Cependant, une surintensité circulant pendant longtemps dans le module E/S distant de sécurité CC-Link peut être à l'origine d'un dégagement de fumée ou d'un départ de feu. Pour éviter cela, prévoir un circuit de sécurité extérieur au module, avec un fusible par exemple.*
- *Quand le module E/S distant de sécurité détecte une erreur de sécurité CC-Link, il désactive toutes les sorties.
On remarquera que, dans un programme séquentiel, les sorties ne sont pas toujours automatiquement désactivées.
Prévoir dans le programme séquentiel la désactivation des sorties dans l'éventualité où une erreur de sécurité CC-Link serait détectée.
Le rétablissement de la sécurité CC-Link alors que les sorties sont actives pourrait causer un brusque mouvement à l'origine d'un accident.*
- *Pour interdire tout redémarrage sans intervention manuelle après déclenchement de la fonction de sécurité du module et mise hors tension des sorties, prévoir un circuit de mise en sécurité avec poussoir de réarmement.*



ATTENTION

- *Ne pas grouper les fils des dispositifs externes ou câbles de communication avec les fils des circuits principaux ou de l'alimentation, et ne pas les installer à proximité les uns des autres.
Ils doivent être installés à une distance de 100mm (3,94 pouces) les uns des autres.
Faute de quoi, il y a risque de bruit entraînant des dysfonctionnements.*
- *En choisissant les dispositifs externes à raccorder au module E/S distant de sécurité CC-Link, prendre en compte l'intensité maximum admissible du courant d'appel en se reportant au manuel de l'utilisateur du module E/S distant pour système de sécurité CC-Link.*

[Précautions d'installation]



ATTENTION

- *Un automate programmable de sécurité doit être utilisé dans un environnement conforme aux spécifications générales exposées dans le QSCPU User's Manual (Hardware Design, Maintenance and Inspection) (le Manuel de l'utilisateur QSCPU (conception du matériel, maintenance et inspection).
L'utilisation de cet automate programmable dans un environnement autre que celui prévu dans les spécifications générales peut être à l'origine d'un choc électrique, d'un départ de feu ou d'un fonctionnement erratique, ou peut endommager ou détériorer le produit.*
- *Il est indispensable de fixer le module E/S distant de sécurité CC-Link sur rail DIN pour par des vis de fixation serrées au couple prescrit.
Si le serrage est insuffisant, les vis ou le module risquent de tomber.
Un serrage excessif peut endommager la vis ou le module et entraîner leur chute.*
- *Éviter tout contact direct avec les parties conductrices ou les composants électroniques du module. Toucher aux parties conductrices pourrait endommager le module ou provoquer des dysfonctionnements.*

[Précautions de câblage]



AVERTISSEMENT

- *Couper complètement l'alimentation externe utilisé par le système avant de mettre en place les câbles. Ne pas couper complètement toutes les alimentations expose au risque de chocs électriques et d'endommagement du produit.*
- *Avant de mettre sous tension et de mettre en marche le module à la fin des travaux d'installation et de câblage, ne oublier de refermer le couvercle- bornes fourni. Faute de quoi, il y a risque de choc électrique.*

[Précautions de câblage]



ATTENTION

- *Il est indispensable de mettre les bornes FG et les bornes LG à la masse sur le conducteur de terre.
faute de quoi, il y a risque de choc électrique ou de fonctionnement erratique.*
- *Pour tout câblage dans l'automate programmable, s'assurer que c'est possible compte tenu de la tension nominale du produit et de l'affectation des bornes.
Le raccordement d'une alimentation d'une tension autre que la tension nominale ou une erreur de câblage du produit peut être à l'origine d'un départ de feu ou d'une panne.*
- *Serrer les vis de fixation du bornier, les vis de borne et les vis de fixation du module dans les limites du couple de serrage prescrit. Une vis de fixation de bornier ou un vis de borne mal serrée peut être à l'origine d'un court-circuit, d'un départ de feu ou de dysfonctionnements. Un serrage excessif peut endommager la vis et/ou le module, et une chute de vis ou de module risque d'entraîner un court-circuit ou des dysfonctionnements. Un serrage insuffisant des vis de fixation de module peut être à l'origine d'une chute des vis ou du module. Un serrage excessif peut endommager la vis ou le module et entraîner leur chute.*
- *Ne pas entremêler les lignes de commandes ou câbles de communication avec les lignes des circuits principaux ou les câbles d'alimentation. Faute de quoi, il y a risque de dysfonctionnement par un bruit.*
- *Veiller à ce qu'il n'y ait pas de sciure ou autre débris de câblage dans le module.
Tout débris pourrait être à l'origine d'un départ de feu, d'une panne ou d'un dysfonctionnement.*
- *Les câbles de communication ou câbles d'alimentation raccordés au module doivent être placés dans des conduits de câbles ou doivent être attachés.
Faute de quoi, il y a risque d'endommagement du module ou du câble par ballotement ou effort de traction exercé accidentellement sur le câble, tout mauvais contact d'un câble pouvant être à l'origine de dysfonctionnement.*
- *Pour débrancher les câbles de communication ou d'alimentation, ne pas tirer sur le câble proprement dit.
Retirer le câble raccordé au bornier après avoir desserré les vis de bornes.
Tirer sur un câble raccordé au module peut endommager le câble ou le module et être à l'origine de dysfonctionnements.*

[Précautions de démarrage et de maintenance]



AVERTISSEMENT

- *Ne pas toucher aux bornes quand l'appareil est sous tension. Cela pourrait être à l'origine de chocs ou d'un fonctionnement erratique.*
- *Couper l'alimentation externe utilisée par le système sur toutes phases avant de nettoyer le module ou de resserrer les vis de fixation du bornier, les vis de bornes ou les vis de fixation du module.*
Faute de quoi, il y a risque de choc électrique. Serrer les vis de fixation du bornier, les vis de borne et les vis de fixation du module dans les limites du couple de serrage prescrit. Une vis de fixation de bornier ou un vis de borne mal serrée peut être à l'origine d'un court-circuit, d'un départ de feu ou de dysfonctionnements. Un serrage excessif peut endommager la vis et/ou le module, et une chute de vis ou de module risque d'entraîner un court-circuit ou des dysfonctionnements. Un serrage insuffisant des vis de fixation de module peut être à l'origine d'une chute des vis ou du module. Un serrage excessif peut endommager la vis ou le module et entraîner leur chute.



ATTENTION

- *Ne pas démonter ni modifier les modules.*
Cela pourrait être à l'origine de pannes, de dysfonctionnements, de blessures ou d'un départ de feu. dysfonctionnements.
Si le produit est réparé ou modifié par quiconque autre que nous-mêmes ou un de nos centre d'automatisation industrielles agréés, il n'est plus couvert par la garantie.
- *Après la mise en service du produit, ne pas installer/retirer le module de l'unité de base ou de la plaque à bornes plus de 50 fois (selon IEC61131-2).*
Faute de quoi, il y a risque de dysfonctionnements du module.
- *Ne pas faire tomber ou soumettre le module à des chocs car son boîtier en plastique est fragile. Cela risquerait d'endommager le module.*
- *Couper complètement toute alimentation externe utilisée par le système avant de mettre en place ou de retirer le module du tableau.*
Faute de quoi, il y a risque d'endommagement du produit.

[Précaution de mise au rebut]



ATTENTION

- *Lors de sa mise au rebut, ce produit doit être traité comme un déchet industriel.*

● CONDITIONS OF USE FOR THE PRODUCT ●

- (1) Although MELCO has obtained the certification for Product's compliance to the international safety standards IEC61508, EN954-1/ISO13849-1 from TUV Rheinland, this fact does not guarantee that Product will be free from any malfunction or failure. The user of this Product shall comply with any and all applicable safety standard, regulation or law and take appropriate safety measures for the system in which the Product is installed or used and shall take the second or third safety measures other than the Product. MELCO is not liable for damages that could have been prevented by compliance with any applicable safety standard, regulation or law.

- (2) MELCO prohibits the use of Products with or in any application involving, and MELCO shall not be liable for a default, a liability for defect warranty, a quality assurance, negligence or other tort and a product liability in these applications.
 - (a) power plants,
 - (b) trains, railway systems, airplanes, airline operations, other transportation systems,
 - (c) hospitals, medical care, dialysis and life support facilities or equipment,
 - (d) amusement equipments,
 - (e) incineration and fuel devices,
 - (f) handling of nuclear or hazardous materials or chemicals,
 - (g) mining and drilling,
 - (h) and other applications where the level of risk to human life, health or property are elevated.

REVISIONS

* The manual number is given on the bottom right of the cover.

Print Date	*Manual Number	Revision
Apr., 2008	IB(NA)-0800414-A	First printing
Jul., 2009	IB(NA)-0800414-B	<div style="border: 1px solid black; display: inline-block; padding: 2px;">Correction</div> COMPLIANCE WITH THE EMC AND LOW VOLTAGE DIRECTIVES, Section 2.2, 2.3, 2.4, Chapter 3, Section 4.1, 4.2, Chapter 5
Jun., 2010	IB(NA)-0800414-C	<div style="border: 1px solid black; display: inline-block; padding: 2px;">Correction</div> SAFETY PRECAUTIONS, Chapter 4 <div style="border: 1px solid black; display: inline-block; padding: 2px;">Additions</div> CONDITIONS OF USE FOR THE PRODUCT, Section 1.1, 2.5, 2.6, Chapter 7, 8
Apr., 2011	IB(NA)-0800414-D	<div style="border: 1px solid black; display: inline-block; padding: 2px;">Correction</div> SAFETY PRECAUTIONS, Section 2.2, 2.5, Chapter 8
Aug., 2011	IB(NA)-0800414-E	<div style="border: 1px solid black; display: inline-block; padding: 2px;">Correction</div> SAFETY PRECAUTIONS, Section 2.1, 4.1 <div style="border: 1px solid black; display: inline-block; padding: 2px;">Additions</div> SAFETY PRECAUTIONS (Chinese)
Nov., 2013	IB(NA)-0800414-F	<div style="border: 1px solid black; display: inline-block; padding: 2px;">Correction</div> Section 2.1 <div style="border: 1px solid black; display: inline-block; padding: 2px;">Additions</div> Section 5.5
Jun., 2014	IB(NA)-0800414-G	<div style="border: 1px solid black; display: inline-block; padding: 2px;">Correction</div> Section 2.1, 2.2, 2.5, 4.1, 5.2, Chapter 8 <div style="border: 1px solid black; display: inline-block; padding: 2px;">Additions</div> SAFETY PRECAUTIONS (French)

This manual confers no industrial property rights or any rights of any other kind, nor does it confer any patent licenses. Mitsubishi electric Corporation cannot be held responsible for any problems involving industrial property rights which may occur as a result of using the contents noted in this manual.

© 2008 MITSUBISHI ELECTRIC CORPORATION

CONTENTS

1. OVERVIEW	1
1.1 Safety Programmable Controller Product List	1
2. SPECIFICATIONS	2
2.1 General Specifications	2
2.2 Performance Specifications	3
2.3 Cable Specifications	6
2.4 Confirming Production Information	6
2.5 Safety Standards	7
2.6 Module Replacement	7
3. PART NAMES AND SETTINGS	8
4. MOUNTING AND INSTALLATION	11
4.1 Handling Precautions	11
4.2 Installation Environment	12
5. WIRING	13
5.1 Precautions for Handling CC-Link Dedicated Cables	13
5.2 Connecting CC-Link Dedicated Cables	13
5.3 Precautions for Wiring Module Power Supply	14
5.4 Precautions for Wiring Safety Devices	15
5.5 Safety devices and wiring example	16
6. EXTERNAL DIMENSIONS	18
7. PRECAUTIONS FOR USE	19
8. EC DECLARATION OF CONFORMITY FOR MACHINERY DIRECTIVE ...	20

ABOUT MANUAL

The following manual is also related to this product.
In necessary, order it by quoting the details in the table below.

Detailed Manual

Manual name	Manual No. (Model code)
CC-Link Safety System Master Module User's Manual QS0J61BT12	SH-080600ENG (13JR88)
CC-Link Safety System Remote I/O Module User's Manual	SH-080612ENG (13JR89)

COMPLIANCE WITH THE EMC, LOW VOLTAGE, AND MACHINERY DIRECTIVES

(1) Method of ensuring compliance

To ensure that Mitsubishi programmable controllers maintain EMC, Low Voltage, and Machinery Directives when incorporated into other machinery or equipment, certain measures may be necessary. Please refer to the manual included with the base unit.

The CE mark on the side of the programmable controller indicates compliance with EMC, Low Voltage, and Machinery Directives.

(2) Additional measures

This product complies with the EMC, Low Voltage, and Machinery Directives. Before using this product, please read this manual, the relevant manuals, the manuals for standard programmable controllers, and the safety standards carefully and pay full attention to safety to handle the product correctly.

The descriptions are based on the requirements of the Directives and the harmonized standards. However, they do not guarantee that the entire machinery constructed according to the descriptions complies with the EMC, Low Voltage, and Machinery Directives. The manufacture of the machinery must determine the testing method for compliance and declare conformity to the EMC, Low Voltage, and Machinery Directives.

1. OVERVIEW

This manual describes the specifications and handling and wiring methods of the safety remote I/O module of the CC-Link Safety system.

After unpacking, confirm that the following are included.

Item	Quantity
QS0J65BTS2-8D	1
CC-Link Safety System Remote I/O Module User's Manual (Hardware)QS0J65BTS2-8D	1

1.1 Safety Programmable Controller Product List

Product Name	Model	Description
CC-Link Safety system remote I/O module	QS0J65BTS2-8D	A safety input module connected to external devices. The module has eight safety input points and sends/receives safety data to/from the safety programmable controller over CC-Link Safety.

2. SPECIFICATIONS

2.1 General Specifications

The general specifications of the QS0J65BTS2-8D are shown below.

Item	Specification					
Operating ambient temperature <i>Température ambiante de fonctionnement</i>	0 to 55°C 0 à 55 °C					
Storage ambient temperature	-40 to 75°C					
Operating ambient humidity	5 to 95%RH, non-condensing					
Storage ambient humidity						
Vibration resistance	Compliant with JIS B 3502 and IEC 61131-2		Frequency	Constant acceleration	Half amplitude	Sweep count
		Under intermittent vibration	5 to 8.4Hz	----	3.5mm	10 times each in X, Y, Z directions
			8.4 to 150Hz	9.8m/s ²	----	
		Under continuous vibration	5 to 8.4Hz	----	1.75mm	----
8.4 to 150Hz	4.9m/s ²		----			
Shock resistance	Compliant with JIS B 3502 and IEC 61131-2 (147m/s ² , duration of action 11ms, 3 times each in 3 directions X, Y, Z by sine half-wave pulse)					
Operating atmosphere	No corrosive gases					
Operating altitude ^{*3}	0 to 2000m					
Installation location	Inside a control panel					
Overvoltage category ^{*1}	II or less					
Pollution degree ^{*2}	2 or less					
Equipment class	Class III					

*1 This indicates the section of the power supply to which the equipment is assumed to be connected between the public electrical power distribution network and the machinery within premises.
Category II applies to equipment for which electrical power is supplied from fixed facilities. The surge voltage withstand level for up to the rated voltage of 300V is 2500V.

*2 This index indicates the degree to which conductive material is generated in terms of the environment in which the equipment is used. Pollution degree 2 is when only non-conductive pollution occurs. A temporary conductivity caused by condensing must be expected occasionally.

*3 Do not use or store the programmable controller under pressure higher than the atmospheric pressure of altitude 0m. Doing so may cause malfunction. When using the programmable controller under pressure, please consult your local Mitsubishi representative.

2.2 Performance Specifications

The performance specifications of the QS0J65BTS2-8D are shown below.

Item		DC input module
		QS0J65BTS2-8D
No. of input points*2		8 points (doubling input), 16 points (single input)
Isolation method		Photocoupler
Rated input voltage		24V DC
Rated input current		Approx. 5.9mA
Operating voltage range		19.2V to 28.8V DC (Ripple ratio: 5% or less)
Maximum number of simultaneous input points		100%
ON voltage/ON current		15V DC/2mA or more
OFF voltage/OFF current		5V DC/0.5mA or less
Input resistance		Approx. 4.3k Ω
Input format		Negative common (source type)
Response time	OFF \rightarrow ON	0.4ms or less (at 24V DC)
	ON \rightarrow OFF	0.4ms or less (at 24V DC)
Safety remote station input response time		11.2ms or less + time of noise removal filter (1ms, 5ms, 10ms, 20ms, 50ms)
External power supply	Voltage	19.2V to 28.8V DC (Ripple ratio: 5% or less)
	Current	40mA (24VDC, all points ON, excluding external load current)
	Protection function	External power supply overvoltage/overcurrent protection function
	Fuse	8A (Not replaceable)
Wiring method for common		16 input points per common (Spring clamp terminal block 2-wire type)
Number of occupied stations		1 station
Number of accesses to nonvolatile memory inside module		10 ¹² times
Safety refresh response processing time		9.6ms
Module power supply*1	Voltage	19.2V to 28.8V DC (Ripple ratio: 5% or less)
	Current	120mA or less (24V DC, all points ON)
	Protection function	Module power supply overvoltage/overcurrent protection function
	Fuse	0.8A (Not replaceable)
	Momentary power failure period	10ms or less
Noise immunity		Tested by a DC-type noise simulator with noise voltage of 500Vp-p, noise width of 1 μ s and frequency of 25 to 60Hz.
Dielectric withstand voltage		500V AC between all external DC terminals and ground, for 1 minute

Item		DC input module
		QS0J65BTS2-8D
Insulation resistance		10M Ω or more between all external DC terminals and ground, by a 500VDC insulation resistance tester
Level of protection		IP2X
Weight		0.46kg
External connection system Système de connexion externe	Communication section, module power supply section <i>Section communication, section alimentation du module</i>	7-point two-piece terminal block [Transmission circuits, module power, FG] M3 x 5.2 Tightening torque: 0.425 to 0.575N•m, 2 solderless terminals or less <i>Bornier 7-points deux-pièces</i> <i>[Circuit de transmission, alimentation module, FG]</i> <i>M3 x 5,2 Couple de serrage : 0,425 à 0,575 N•m,</i> <i>2 bornes sans soudure ou moins</i>
	External power supply section, input section <i>Section alimentation externe, section entrée</i>	Two-piece spring clamp terminal block [External power supply, input section] <i>Bornier à étrier deux-pièces</i> <i>[Alimentation externe, section entrée]</i>
Module mounting screw		M4 screw with plain washer finished round (Tightening torque: 0.824 to 1.11N•m) Mountable with a DIN rail, and in 6 orientations.
Applicable DIN rail		TH35-7.5Fe, TH35-7.5Al (Compliant with IEC 60715)

Item		DC input module
		QS0J65BTS2-8D
Applicable wire size <i>Taille du fil à utiliser</i>	Communication section, module power supply section <i>Section communication, section alimentation du module</i>	0.3 to 2.0mm ² <i>0,3 à 2,0 mm²</i>
	Applicable solderless terminal <i>Borne sans soudure à utiliser</i>	<ul style="list-style-type: none"> • RAV1.25-3 [Applicable wire size: 0.3 to 1.25mm²] • V2-MS3 (JST Mfg. Co., Ltd.), RAP2-3SL (Nippon Tanshi Co., Ltd.), TGV2-3N (Nichifu) [Applicable wire size: 1.25 to 2mm²] • RAV1.25-3 [Taille du fil à utiliser: 0,3 à 1,25 mm²] • V2-MS3 (JST Mfg. Co., Ltd.), RAP2-3SL (Nippon Tanshi Co., Ltd.), TGV2-3N (Nichifu) [Taille de fil à utiliser : 1,25 à 2mm²]
	External power supply section, input section <i>Section alimentation externe, section entrée</i>	Twisted wire 0.08 to 1.5mm ² (28 to 16AWG) *3 Applicable wire strip length: 8 to 11mm <i>Fil torsadé 0,08 à 1,5mm² (28 à 16AWG) *3</i> <i>Longueur de fil à dénuder : 8 à 11mm</i>
	Applicable solderless terminal <i>Borne sans soudure à utiliser</i>	<ul style="list-style-type: none"> • TE0.5 (Nichifu) [Applicable wire size: 0.5mm²] • TE0.75 (Nichifu) [Applicable wire size: 0.75mm²] • TE1 (Nichifu) [Applicable wire size: 0.9 to 1.0mm²] • TE1.5 (Nichifu) [Applicable wire size: 1.25 to 1.5mm²] • FA-VTC125T9 (Mitsubishi Electric Engineering Co.,Ltd. [Applicable wire size: 0.3 to 1.65mm²] • FA-VTCW125T9 (Mitsubishi Electric Engineering Co.,Ltd. [Applicable wire size: 0.3 to 1.65mm²] <i>TE0.5 (Nichifu) [Taille de fil à utiliser : 0,5mm²]</i> <i>TE0.75 (Nichifu) [Taille de fil à utiliser : 0,75mm²]</i> <i>TE1 (Nichifu) [Taille de fil à utiliser : 0,9 à 1,0mm²]</i> <i>TE1.5 (Nichifu) [Taille de fil à utiliser : 1,25 à 1,5mm²]</i> <i>FA-VTC125T9 (Mitsubishi Electric Engineering Co.,Ltd. [Taille de fil à utiliser : 0,3 à 1,65mm²]</i> <i>FA-VTCW125T9 (Mitsubishi Electric Engineering Co.,Ltd. [Taille de fil à utiliser : 0,3 à 1,65mm²]</i>

- *1 The power supply connected to the QS0J65BTS2-8D must satisfy the following conditions:
 - (1) Reinforced insulation
SELV (Safety Extra Low Voltage): Hazardous potential part (48V or more)
 - (2) Compliance with the LVD (Low Voltage Directive)
 - (3) Output voltage within 19.2V to 28.8V DC
(Ripple ratio: 5% or less.)
- *2 For module technical version C or earlier, the number of input points is 8 points. (Two inputs terminals are assigned for each input since dual wiring is supported.)
- *3 Do not insert two or more wires into one terminal.
- *3 *Ne pas introduire deux fils, ou plus de deux, dans une même borne.*

2.3 Cable Specifications

Use CC-Link dedicated cables for the CC-Link Safety system. The performance of the CC-Link Safety system cannot be guaranteed when any other cables are used. For the specifications or any other inquiries, visit the following website: CC-Link Partner Association: <http://www.cc-link.org/>

Remark

For details, refer to the CC-Link Cable Wiring Manual issued by the CC-Link Partner Association.

2.4 Confirming Production Information

The production information of the QS0J65BTS2-8D can be confirmed on the rating plate located on the side of the module.

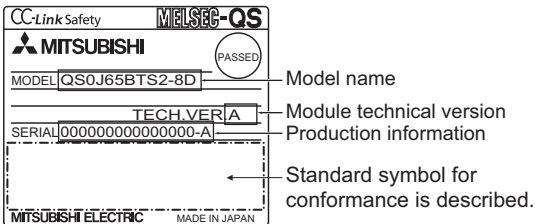

2.5 Safety Standards

Normes de sécurité

Use the product according to the following safety standards.

Region	Safety Standards
International	IEC61508 Parts 1-7:1998-2000, ISO13849-1:2006, IEC61131-2:2007, IEC61000-6-2:2005, IEC61000-6-4:2006, IEC61784-3:2010, IEC60204-1:2006
Europe	EN954-1:1996, EN ISO13849-1:2008, EN61131-2:2007, EN61000-6-2:2005, EN61000-6-4:2007
North America	UL508, NFPA79-2007

Utiliser le produit dans le respect des normes de sécurité suivantes.

Région	Normes de sécurité
International	IEC61508 Parts 1-7:1998-2000, ISO13849-1:2006, IEC61131-2:2007, IEC61000-6-2:2005, IEC61000-6-4:2006, IEC61784-3:2010, IEC60204-1:2006
Europe	EN954-1:1996, EN ISO13849-1:2008, EN61131-2:2007, EN61000-6-2:2005, EN61000-6-4:2007
Amérique du Nord	UL508, NFPA79-2007

2.6 Module Replacement

Replace the module according to the following replacement cycle.

Module	Replacement Cycle
CC-Link Safety system remote I/O module	5 years

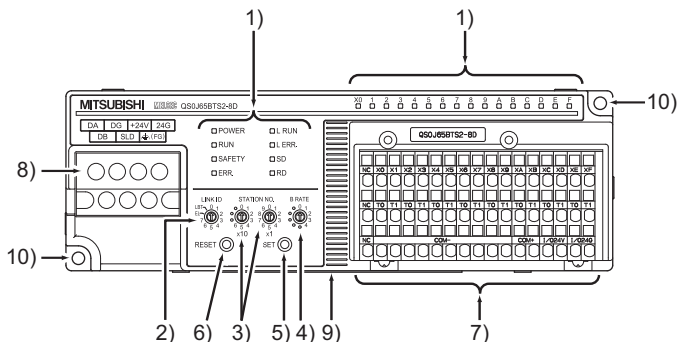

3. PART NAMES AND SETTINGS

The name of each part in the QS0J65BTS2-8D is shown.



No.	Name	Description								
1)	Indicator LEDs	<table border="1"> <thead> <tr> <th>LED name</th> <th>Indication</th> </tr> </thead> <tbody> <tr> <td>"POWER"</td> <td> <p>Indicates the power status of the safety remote I/O module.</p> <p>ON (green) : Normally powered</p> <p>OFF : Powered off or error occurred (blown fuse)</p> </td> </tr> <tr> <td>"RUN"^{*1}</td> <td> <p>Indicates the operating status of the safety remote I/O module.</p> <p>ON (green) : Normally operating, or moderate error occurred</p> <p>Flashing at 500ms-intervals (green) : Switch setting has been registered but not fixed yet or reading of error history data have been completed normally.</p> <p>Flashing at 100ms-intervals (green) : Setting has been registered normally.</p> <p>OFF : Major error occurred</p> </td> </tr> <tr> <td>"SAFETY"^{*1}</td> <td> <p>Indicates the CC-Link Safety system connection status of the safety remote I/O module.</p> <p>ON (green) : Connected to CC-Link Safety system^{*2}, or self-loopback test completed normally</p> <p>Flash (green):Self-loopback test in execution</p> <p>OFF : Not connected to CC-Link Safety system, or self-loopback test completed in error</p> </td> </tr> </tbody> </table>	LED name	Indication	"POWER"	<p>Indicates the power status of the safety remote I/O module.</p> <p>ON (green) : Normally powered</p> <p>OFF : Powered off or error occurred (blown fuse)</p>	"RUN" ^{*1}	<p>Indicates the operating status of the safety remote I/O module.</p> <p>ON (green) : Normally operating, or moderate error occurred</p> <p>Flashing at 500ms-intervals (green) : Switch setting has been registered but not fixed yet or reading of error history data have been completed normally.</p> <p>Flashing at 100ms-intervals (green) : Setting has been registered normally.</p> <p>OFF : Major error occurred</p>	"SAFETY" ^{*1}	<p>Indicates the CC-Link Safety system connection status of the safety remote I/O module.</p> <p>ON (green) : Connected to CC-Link Safety system^{*2}, or self-loopback test completed normally</p> <p>Flash (green):Self-loopback test in execution</p> <p>OFF : Not connected to CC-Link Safety system, or self-loopback test completed in error</p>
		LED name	Indication							
		"POWER"	<p>Indicates the power status of the safety remote I/O module.</p> <p>ON (green) : Normally powered</p> <p>OFF : Powered off or error occurred (blown fuse)</p>							
"RUN" ^{*1}	<p>Indicates the operating status of the safety remote I/O module.</p> <p>ON (green) : Normally operating, or moderate error occurred</p> <p>Flashing at 500ms-intervals (green) : Switch setting has been registered but not fixed yet or reading of error history data have been completed normally.</p> <p>Flashing at 100ms-intervals (green) : Setting has been registered normally.</p> <p>OFF : Major error occurred</p>									
"SAFETY" ^{*1}	<p>Indicates the CC-Link Safety system connection status of the safety remote I/O module.</p> <p>ON (green) : Connected to CC-Link Safety system^{*2}, or self-loopback test completed normally</p> <p>Flash (green):Self-loopback test in execution</p> <p>OFF : Not connected to CC-Link Safety system, or self-loopback test completed in error</p>									

No.	Name	Description								
1)	Indicator LEDs	<p>"ERR."^{*1}</p> <p>Indicates failure or error status of the safety remote I/O module.</p> <p>ON (red) : Major error occurred, or self-loopback test completed in error</p> <p>"RUN" LED OFF: Major error occurred</p> <p>Flashing at 500ms-intervals (red) : Moderate error occurred or reading of error history data have been completed abnormally.</p> <p>Flashing at 100ms-intervals (red) : The registered switch setting differs from the actual switch setting.</p> <p>OFF : Normally operating</p>								
		<p>"L RUN"</p> <p>Indicates the communication status of the safety remote I/O module in the CC-Link Safety system.</p> <p>ON (green) : Normally communicating in the CC-Link Safety system</p> <p>OFF : Communication failure in the CC-Link Safety system (Timeout error)</p>								
		<p>"L ERR."</p> <p>Indicates the communication error status of the safety remote I/O module in the CC-Link Safety system.</p> <p>ON (red) : Value set by link ID, station No, or transmission setting switch is out of range</p> <p>Flash regularly (red) : Setting of link ID, station No, and/or transmission setting switch is different from that of the internal nonvolatile memory</p> <p>Flash irregularly (red) : Wrong terminating resistor setting, or noise influence</p> <p>OFF : Normally operating</p>								
		<p>"SD"</p> <p>Indicates the sending status of the safety remote I/O module in the CC-Link Safety system.</p> <p>ON (green) : Data being sent</p>								
		<p>"RD"</p> <p>Indicates the receiving status of the safety remote I/O module in the CC-Link Safety system.</p> <p>ON (green) : Data being received</p>								
		<p>"X0" to "XF"</p> <p>Indicates the Input status of the safety remote I/O module.</p> <p>ON (red) : Input ON</p> <p>OFF : Input OFF</p>								
2)	Link ID setting switch ^{*4}	<table border="1" data-bbox="418 1100 926 1239"> <thead> <tr> <th data-bbox="418 1100 586 1129">Setting</th> <th data-bbox="586 1100 926 1129">Description</th> </tr> </thead> <tbody> <tr> <td data-bbox="418 1129 586 1166">0 to 7</td> <td data-bbox="586 1129 926 1166">Link ID setting</td> </tr> <tr> <td data-bbox="418 1166 586 1202">EL</td> <td data-bbox="586 1166 926 1202">Setting for reading error logs</td> </tr> <tr> <td data-bbox="418 1202 586 1239">LBT</td> <td data-bbox="586 1202 926 1239">Setting for self-loopback test</td> </tr> </tbody> </table> <p data-bbox="373 1246 964 1290">To refresh the switch setting, perform the reset operation or turn the power OFF → ON of the safety remote I/O module.</p>	Setting	Description	0 to 7	Link ID setting	EL	Setting for reading error logs	LBT	Setting for self-loopback test
Setting	Description									
0 to 7	Link ID setting									
EL	Setting for reading error logs									
LBT	Setting for self-loopback test									

No.	Name	Description												
3)	Station No. setting switch*4	Set station No. of the safety remote I/O module within a range from 0 to 64.*3 <ul style="list-style-type: none"> • Tens place of station No. is set by  X10. • Units place of station No. is set by  X1. 												
4)	Transmission speed setting switch*4	<table border="1" data-bbox="376 230 888 438"> <thead> <tr> <th>Setting</th> <th>Transmission speed</th> </tr> </thead> <tbody> <tr> <td>0</td> <td>156kbps</td> </tr> <tr> <td>1</td> <td>625kbps</td> </tr> <tr> <td>2</td> <td>2.5Mbps</td> </tr> <tr> <td>3</td> <td>5Mbps</td> </tr> <tr> <td>4</td> <td>10Mbps</td> </tr> </tbody> </table> <p>Always set this switch within a range of 0 to 4.</p>	Setting	Transmission speed	0	156kbps	1	625kbps	2	2.5Mbps	3	5Mbps	4	10Mbps
Setting	Transmission speed													
0	156kbps													
1	625kbps													
2	2.5Mbps													
3	5Mbps													
4	10Mbps													
5)	Setting saving switch*4	Saves the values set by switches 2) to 4) into the nonvolatile memory inside the safety remote I/O module.												
6)	Reset switch*4	Resets the hardware of the safety remote I/O module.												
7)	I/O terminal block	Two-piece spring clamp terminal block for connection of external power supply and I/O signals.												
8)	Power supply, transmission terminal block	Two-piece terminal block for connection of module power supply and transmission signal.												
9)	Hook for DIN rail	Hook used for installing the module to a DIN rail. Press the center part of the hook until a click is heard.												
10)	Mounting hole for screw installation	A hole used when installing a module directly to a panel.												

*1 Although the "RUN", "SAFETY" and "ERR." LEDs momentarily turn on immediately after power ON or reset, it does not mean any fault.

*2 The "SAFETY" LED is off when no safety remote I/O station parameters have been received during connection to the CC-Link Safety system.

*3 Duplicate station number setting is not allowed.

*4 For the switch setting methods, refer to the CC-Link Safety System Remote I/O Module User's Manual.

4. MOUNTING AND INSTALLATION

4.1 Handling Precautions

This section provides handling precautions for use of the safety remote I/O module.

- (1) Do not drop the safety remote I/O module or apply any strong impact to it.
- (2) Do not remove the printed circuit board (PCB) of the safety remote I/O module from the case.
Doing so may cause failure.
- (3) Carefully prevent any dust or wiring chips from entering the safety remote I/O module.
Failure to do so may cause a fire, failure, or malfunction.
- (4) When installing the safety remote I/O module to a control panel, provide clearance of at least 60mm between the module's top/ bottom and any other structure or component to ensure proper airflow and to make module replacement easy.
- (5) Install the safety remote I/O module to a flat surface.
If it is not flat, an excess force may be applied to the PCB, causing failure.
- (6) Tighten the module mounting screws and terminal screws within the following torque range.
Overtightening may result in damage to the screws or the module case.

Serrer les vis de fixation du module et les vis de borne dans les limites du couple de serrage prescrit.

Un serrage excessif peut endommager les vis ou le boîtier du module.

Screw	Specified torque range
Module mounting screw (M4 screw with plain washer finished round)	0.824 to 1.110N·m
Terminal screw (M3 screw) <i>Vis de borne (Vis M3)</i>	0.425 to 0.525N·m <i>0,425 à 0,525 N·m</i>
2-piece terminal block mounting screw (M3.5 screw)	0.680 to 0.920N·m

- (7) When using a DIN rail, pay attention to the following:
- (a) Applicable DIN rail model (conforming to IEC 60715)
 - TH35-7.5Fe
 - TH35-7.5Al
 - (b) Installation screw intervals
 - Tighten the screws at pitches of 200mm (7.88 inch) or less.
- (8) When installing the safety remote I/O module to the DIN rail, press the center part of the hook located on the bottom of the module until a click is heard.

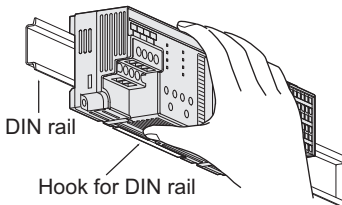

Note: Do not press the front face as shown below. Doing so may cause failure.

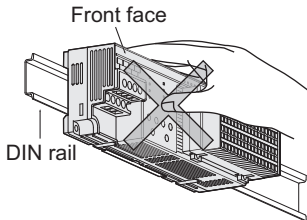

- (9) If the mechanical power supply switch is used for the safety remote I/O module, in rare cases it does not operate, when the excessive chattering is generated at power-on, and safety diagnostics function operates due to the unstable status of the input power supply voltage.
- In this case, turn on power supply again.

4.2 Installation Environment

For installation environment, refer to "2.1 General Specifications".

5. WIRING

5.1 Precautions for Handling CC-Link Dedicated Cables

This section explains how to handle CC-Link dedicated cables. Do not perform any of the following, as each of them will damage CC-Link dedicated cables:

- Compressing the cable with a sharp object
- Twisting the cable excessively
- Pulling the cable too hard (exceeding the allowable tension)
- Stepping on the cable
- Placing an object on the cable
- Scratching the cable sheath

5.2 Connecting CC-Link Dedicated Cables

The following figure shows how safety remote I/O modules are connected with CC-Link dedicated cables.

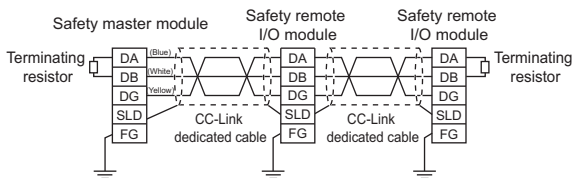

English	French	English	French
Safety master module	<i>Module maître de sécurité</i>	Terminating resistor	<i>Résistance d'extrémité</i>
Safety remote I/O module	<i>Module E/S de sécurité distant</i>	CC-Link dedicated cable	<i>Câble dédié pour CC-Link</i>
Blue	<i>Bleu</i>	White	<i>Blanc</i>
Yellow	<i>Jaune</i>		

POINT

1) Connect the shielded wire of the CC-Link dedicated cable to SLD terminal of each module, and ground both ends to the protective ground connectors via FG terminals.

The SLD and FG terminals are connected inside the module.

2) Always connect terminating resistors to the modules located on both ends of the data link network.

Connect a terminating resistor between DA and DB terminals.

1) Raccorder le fil de blindage du câble dédié CC-Link à la borne SLD de chaque module et mettre les deux extrémités à la masse sur les connecteurs de mise à la terre via les borne FG.

Les bornes SLD et FG sont raccordées à l'intérieur du module.

2) Toujours placer des résistances d'extrémité sur les modules placés aux deux extrémités de la liaison de données.

Raccorder une résistance d'extrémité entre les bornes DA et DB.

5.3 Precautions for Wiring Module Power Supply

When wiring the module power supply of the safety remote I/O module, note the following.

- Cable length of the module power supply must be within 10m (32.81 ft.).

5.4 Precautions for Wiring Safety Devices

This section describes the precautions for wiring to each safety device.

(1) Wiring of the input terminal section

(a) Combinations of input terminals

Input terminals can be used in the following combinations only. Using them in any other combination will result in a moderate error.

- X0 and X1
- X2 and X3
- X4 and X5
- X6 and X7
- X8 and X9
- XA and XB
- XC and XD
- XE and XF

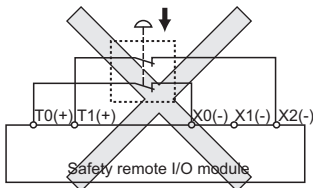
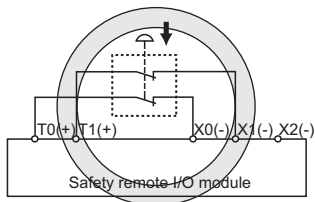

(b) Combinations of the test pulse output terminals

Using the same test pulse for one device is not allowed.

If the same test pulse is used in combinations such as X0 + T0 and X1 + T0, a moderate error will occur.

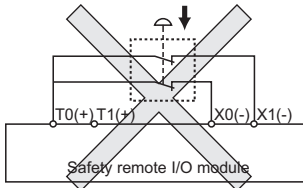
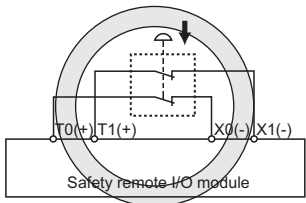

5.5 Safety devices and wiring example

This section describes the wiring between the safety remote I/O module and safety devices.

To satisfy the wiring requirements specified in Category 4, the following two points must be executed in the safety remote I/O module.

- Double input/output wiring
- Execution of the self-diagnostic function (dark test)

The following shows an example of wiring between the safety remote I/O module and the safety device to meet the above points.

For details on the wiring with safety devices, refer to the "Safety Application Guide".

(1) Wiring example of the QS0J65BTS2-8D

(a) Wiring example (with a safety switch (2 NC contacts) and a safety sensor)

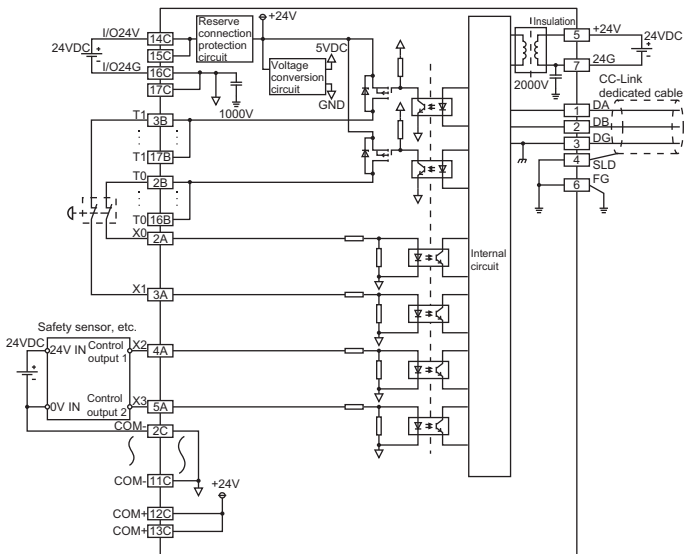

CC-Link terminal

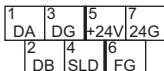

Terminal block

No.	Line C	Line B	Line A
1	Empty	Empty	Empty
2	COM-	T0	X0
3		T1	X1
4		T0	X2
5		T1	X3
6		T0	X4
7		T1	X5
8		T0	X6
9		T1	X7
10		T0	X8
11		T1	X9
12		COM+	T0
13	T1		XB
14	I/O24V	T0	XC
15		T1	XD
16	I/O24G	T0	XE
17		T1	XF

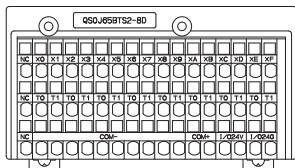

6. EXTERNAL DIMENSIONS

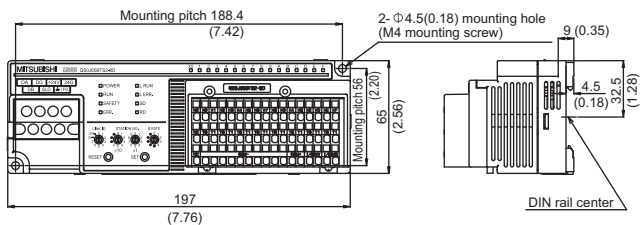
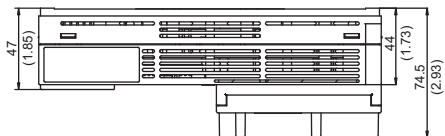

Unit: mm (inch)

7. PRECAUTIONS FOR USE

Users must prove that their entire safety system complies with the safety standards and the Machinery Directive. The third-party certification organization will validate the safety of product for the entire safety system, including a safety programmable controller and safety components.

To establish a safety system, calculate the target failure measure (PFD/PFH) for each safety application (safety function) based on the PFD/PFH values of the safety programmable controller and connected safety components. The target failure measure (PFD/PFH) is the reliability target value for each Safety Integrity Level (SIL) defined in IEC61508 and can be calculated by the following formula.

$PFD/PFH = A + B + C + D$ Calculation formula of PFD/PFH

Variable	Definition
A	Total PFD/PFH of the safety CPU module, safety power supply module, safety main base unit, and CC-Link Safety system master module
B	PFD/PFH of the CC-Link Safety system remote I/O module (1) When safety input device(s) and safety output device(s) are connected to the same CC-Link Safety system remote I/O module: $B=B1$ (2) When safety input device(s) and safety output device(s) are connected to different CC-Link Safety system remote I/O modules: $B=B1+B2$
B1	PFD/PFH of the CC-Link Safety system remote I/O module to which safety input device(s) is connected
B2	PFD/PFH of the CC-Link Safety system remote I/O module to which safety output device(s) is connected
C^{*1}	PFD/PFH of safety input device(s)
D^{*1}	PFD/PFH of safety output device(s)

*1 For the values, refer to the manual for the safety component used.

The following tables show the PFD/PFH values for the safety remote I/O module.

Module	PFD	PFH(/h)
PFD/PFH of the QS0J65BTS2-8D	1.68×10^{-5}	7.46×10^{-10}

8. EC DECLARATION OF CONFORMITY FOR MACHINERY DIRECTIVE

EC Declaration of Conformity

Manufacturer: Mitsubishi Electric Corporation, Nagoya Works
Address: 1-14, 5-chome, Yada-Minami, Higashi-ku, Nagoya
461-8670, Japan

Products: Type: Programmable Controller
(Open Type equipment, Installation category II)
Model: QSD-Series
(Applicable units identified in Appendix)

These products comply with the following European directives:

Directive	Name
2006/42/EC	Machinery Directive

Further details of conformity to these directives are contained in the appendices (BCN-P9999-0618-B later).

Authorised Signature:

T. Takahashi
Senior Manager, FA System Department

Date: (signature)

11/03/2011



Authorised Representative: Mitsubishi Electric Europe BV
in the European Community Gothaer Str. 8, 40880 Ratingen, Germany
through Responsible person
Signature:

H. Pütz
Executive Vice President &
Deputy Product Marketing Director,
FA European Business Group

Date: (signature)

02/03/2011



The appendices are part of this declaration. This declaration certifies the conformity with the directives mentioned, but does not contain any warranted qualities. The installation, usage and safety directions of the product documentation have to be observed.

BCN-P9999-0617-B

Appendix

QS0-Series Programmable Controllers

Range of products:

QS001CPU	5	QS061P-A1-K	5	QS0J65BTB2-12DT-K	5
QS001CPU-K	5	QS061P-A2	5	QS0J65BTS2-4T	5
QS034B	5	QS061P-A2-K	5	QS0J65BTS2-8D	5
QS034B-E	5	QS0J61BT12	5	QS0J71GF11-T2	5
QS034B-K	5	QS0J61BT12-K	5		
QS061P-A1	5	QS0J65BTB2-12DT	5		

The conformity of the above mentioned products with the regulations of the directive 2006/42/EC for machinery is shown by the application of a Technical Construction File. This is supported by selected product tests to the following standards directly and indirectly (when Generic standards are used).

Note: The mentioned products must be used as directed by the associated documentation in order to provide full compliance.

Harmonized European Standards

Reference No.	Date of Issue
EN ISO13849-1	2008

Modules marked with a mark 5 have been tested to EN ISO13849-1(2008)

This declaration is based on the conformity assessment of following Notified Body:

TUV RHEINLAND INDUSTRIE SERVICE GMBH - TUV Rheinland Group Am Grauen Stein D-51105 Köln Germany Phone : +49:221:8060 Fax : +49:221:806114 Email : is@de.tuv.com Website : http://www.tuv.com	NB 0035
EC Type-Examination Certificate	01/205/5201.01/13

Signature *Mitsushiro Fujishima*

Mitsushiro Fujishima
Manager, Safety Products Strategy planning group
FA Systems Dept.2

Revision record

B	30 March 2011	QS0J71GF11-T2 added to the list.
C	12 June 2013	EC Type-Examination Certificate has been updated.
D	20 December 2013	EC Type-Examination Certificate has been updated.

BCN-P9999-0618-D

WARRANTY

Please confirm the following product warranty details before using this product.

1. Limited Warranty and Product Support.

- a. Mitsubishi Electric Company ("MELCO") warrants that for a period of eighteen (18) months after date of delivery from the point of manufacture or one year from date of Customer's purchase, whichever is less, Mitsubishi MELSEC Safety programmable logic controllers (the "Products") will be free from defects in material and workmanship.
- b. At MELCO's option, for those Products MELCO determines are not as warranted, MELCO shall either repair or replace them or issue a credit or return the purchase price paid for them.
- c. For this warranty to apply:
 - (1) Customer shall give MELCO (i) notice of a warranty claim to MELCO and the authorized dealer or distributor from whom the Products were purchased, (ii) the notice shall describe in reasonable details the warranty problem, (iii) the notice shall be provided promptly and in no event later than thirty (30) days after the Customer knows or has reason to believe that Products are not as warranted, and (iv) in any event, the notice must be given within the warranty period;
 - (2) Customer shall cooperate with MELCO and MELCO's representatives in MELCO's investigation of the warranty claim, including preserving evidence of the claim and its causes, meaningfully responding to MELCO's questions and investigation of the problem, grant MELCO access to witnesses, personnel, documents, physical evidence and records concerning the warranty problem, and allow MELCO to examine and test the Products in question offsite or at the premises where they are installed or used; and
 - (3) If MELCO requests, Customer shall remove Products it claims are defective and ship them to MELCO or MELCO's authorized representative for examination and, if found defective, for repair or replacement. The costs of removal, shipment to and from MELCO's designated examination point, and reinstallation of repaired or replaced Products shall be at Customer's expense.
 - (4) If Customer requests and MELCO agrees to effect repairs onsite at any domestic or overseas location, the Customer will pay for the costs of sending repair personnel and shipping parts. MELCO is not responsible for any re-commissioning, maintenance, or testing on-site that involves repairs or replacing of the Products.
- d. Repairs of Products located outside of Japan are accepted by MELCO's local authorized service facility centers ("FA Centers"). Terms and conditions on which each FA Center offers repair services for Products that are out of warranty or not covered by MELCO's limited warranty may vary.
- e. Subject to availability of spare parts, MELCO will offer Product repair services for (7) years after each Product model or line is discontinued, at MELCO's or its FA Centers' rates and charges and standard terms in effect at the time of repair. MELCO usually produces and retains sufficient spare parts for repairs of its Products for a period of seven (7) years after production is discontinued.
- f. MELCO generally announces discontinuation of Products through MELCO's Technical Bulletins. Products discontinued and repair parts for them may not be available after their production is discontinued.

2. Limits of Warranties.

- a. MELCO does not warrant or guarantee the design, specify, manufacture, construction or installation of the materials, construction criteria, functionality, use, properties or other characteristics of the equipment, systems, or production lines into which the Products may be incorporated, including any safety, fail-safe and shut down systems using the Products.
- b. MELCO is not responsible for determining the suitability of the Products for their intended purpose and use, including determining if the Products provide appropriate safety margins and redundancies for the applications, equipment or systems into which they are incorporated.
- c. Customer acknowledges that qualified and experienced personnel are required to determine the suitability, application, design, construction and proper installation and integration of the Products. MELCO does not supply such personnel.
- d. MELCO is not responsible for designing and conducting tests to determine that the Product functions appropriately and meets application standards and requirements as installed or incorporated into the end-user's equipment, production lines or systems.
- e. MELCO does not warrant any Product:
 - (1) repaired or altered by persons other than MELCO or its authorized engineers or FA Centers;
 - (2) subjected to negligence, carelessness, accident, misuse, or damage;
 - (3) improperly stored, handled, installed or maintained;
 - (4) integrated or used in connection with improperly designed, incompatible or defective hardware or software;
 - (5) that fails because consumable parts such as batteries, backlights, or fuses were not tested, serviced or replaced;
 - (6) operated or used with equipment, production lines or systems that do not meet applicable and commensurate legal, safety and industry-accepted standards;
 - (7) operated or used in abnormal applications;
 - (8) installed, operated or used in contravention of instructions, precautions or warnings contained in MELCO's user, instruction and/or safety manuals, technical bulletins and guidelines for the Products;
 - (9) used with obsolete technologies or technologies not fully tested and widely accepted and in use at the time of the Product's manufacture;
 - (10) subjected to excessive heat or moisture, abnormal voltages, shock, excessive vibration, physical damage or other improper environment; or
 - (11) damaged or malfunctioning due to Acts of God, fires, acts of vandals, criminals or terrorists, communication or power failures, or any other cause or failure that results from circumstances beyond MELCO's control.
- f. All Product information and specifications contained on MELCO's website and in catalogs, manuals, or technical information materials provided by MELCO are subject to change without prior notice.
- g. The Product information and statements contained on MELCO's website and in catalogs, manuals, technical bulletins or other materials provided by MELCO are provided as a guide for Customer's use. They do not constitute warranties and are not incorporated in the contract of sale for the Products.
- h. These terms and conditions constitute the entire agreement between Customer and MELCO with respect to warranties, remedies and damages and supersede any other understandings, whether written or oral, between the parties. Customer expressly acknowledges that any representations or statements made by MELCO or others concerning the Products outside these terms are not part of the basis of the bargain between the parties and are not factored into the pricing of the Products.
- i. THE WARRANTIES AND REMEDIES SET FORTH IN THESE TERMS ARE THE EXCLUSIVE AND ONLY WARRANTIES AND REMEDIES THAT APPLY TO THE PRODUCTS.
- j. MELCO DISCLAIMS THE IMPLIED WARRANTIES OF MERCHANTABILITY AND FITNESS FOR A PARTICULAR PURPOSE.

3. Limits on Damages.

- a. MELCO'S MAXIMUM CUMULATIVE LIABILITY BASED ON ANY CLAIMS FOR BREACH OF WARRANTY OR CONTRACT, NEGLIGENCE, STRICT TORT LIABILITY OR OTHER THEORIES OF RECOVERY REGARDING THE SALE, REPAIR, REPLACEMENT, DELIVERY, PERFORMANCE, CONDITION, SUITABILITY, COMPLIANCE, OR OTHER ASPECTS OF THE PRODUCTS OR THEIR SALE, INSTALLATION OR USE SHALL BE LIMITED TO THE PRICE PAID FOR PRODUCTS NOT AS WARRANTED.
- b. Although MELCO has obtained the certification for Product's compliance to the international safety standards IEC61508 and EN954-1/ISO13849-1 from TUV Rheinland, this fact does not guarantee that Product will be free from any malfunction or failure. The user of this Product shall comply with any and all applicable safety standard, regulation or law and take appropriate safety measures for the system in which the Product is installed or used and shall take the second or third safety measures other than the Product. MELCO is not liable for damages that could have been prevented by compliance with any applicable safety standard, regulation or law.
- c. MELCO prohibits the use of Products with or in any application involving power plants, trains, railway systems, airplanes, airline operations, other transportation systems, amusement equipments, hospitals, medical care, dialysis and life support facilities or equipment, incineration and fuel devices, handling of nuclear or hazardous materials or chemicals, mining and drilling, and other applications where the level of risk to human life, health or property are elevated.
- d. MELCO SHALL NOT BE LIABLE FOR SPECIAL, INCIDENTAL, CONSEQUENTIAL, INDIRECT OR PUNITIVE DAMAGES, FOR LOSS OF PROFITS, SALES, OR REVENUE, FOR INCREASED LABOR OR OVERHEAD COSTS, FOR DOWNTIME OR LOSS OF PRODUCTION, FOR COST OVERRUNS, OR FOR ENVIRONMENTAL OR POLLUTION DAMAGES OR CLEAN-UP COSTS, WHETHER THE LOSS IS BASED ON CLAIMS FOR BREACH OF CONTRACT OR WARRANTY, VIOLATION OF STATUTE, NEGLIGENCE OR OTHER TORT, STRICT LIABILITY OR OTHERWISE.
- e. In the event that any damages which are asserted against MELCO arising out of or relating to the Products or defects in them, consist of personal injury, wrongful death and/or physical property damages as well as damages of a pecuniary nature, the disclaimers and limitations contained in these terms shall apply to all three types of damages to the fullest extent permitted by law. If, however, the personal injury, wrongful death and/or physical property damages cannot be disclaimed or limited by law or public policy to the extent provided by these terms, then in any such event the disclaimer of and limitations on pecuniary or economic consequential and incidental damages shall nevertheless be enforceable to the fullest extent allowed by law.
- f. In no event shall any cause of action arising out of breach of warranty or otherwise concerning the Products be brought by Customer more than one year after the cause of action accrues.
- g. Each of the limitations on remedies and damages set forth in these terms is separate and independently enforceable, notwithstanding the unenforceability or failure of essential purpose of any warranty, undertaking, damage limitation, other provision of these terms or other terms comprising the contract of sale between Customer and MELCO.

4. Delivery/Force Majeure.

- a. Any delivery date for the Products acknowledged by MELCO is an estimated and not a promised date. MELCO will make all reasonable efforts to meet the delivery schedule set forth in Customer's order or the purchase contract but shall not be liable for failure to do so.
- b. Products stored at the request of Customer or because Customer refuses or delays shipment shall be at the risk and expense of Customer.
- c. MELCO shall not be liable for any damage to or loss of the Products or any delay in or failure to deliver, service, repair or replace the Products arising from shortage of raw materials, failure of suppliers to make timely delivery, labor difficulties of any kind, earthquake, fire, windstorm, flood, theft, criminal or terrorist acts, war, embargoes, governmental acts or rulings, loss or damage or delays in carriage, acts of God, vandals or any other circumstances reasonably beyond MELCO's control.

5. Choice of Law/Jurisdiction.

These terms and any agreement or contract between Customer and MELCO shall be governed by the laws of the State of New York without regard to conflicts of laws. To the extent any action or dispute is not arbitrated, the parties consent to the exclusive jurisdiction and venue of the federal and state courts located in the Southern District of the State of New York. Any judgment there obtained may be enforced in any court of competent jurisdiction.

6. Arbitration.

Any controversy or claim arising out of, or relating to or in connection with the Products, their sale or use or these terms, shall be settled by arbitration conducted in accordance with the Center for Public Resources (CPR) Rules for Non-Administered Arbitration of International Disputes, by a sole arbitrator chosen from the CPR's panels of distinguished neutrals. Judgment upon the award rendered by the Arbitrator shall be final and binding and may be entered by any court having jurisdiction thereof. The place of the arbitration shall be New York City, New York. The language of the arbitration shall be English. The neutral organization designated to perform the functions specified in Rule 6 and Rules 7.7(b), 7.8 and 7.9 shall be the CPR.

Country/Region	Sales office/Tel	Country/Region	Sales office/Tel
USA	Mitsubishi Electric Automation Inc. 500 Corporate Woods Parkway, Vernon Hills, IL 60061, USA Tel : +1-847-478-2100	South Africa	CBI-Electric. Private Bag 2016, ZA-1600 Isando, South Africa Tel : +27-11-977-0770
Brazil	MELCO-TEC Representacao Comercial e Assessoria Tecnica Ltda. Av. Paulista, 1439, cj74, Bela Vista, Sao Paulo CEP: 01311-200-SP Brazil Tel : +55-11-3146-2200	China	Mitsubishi Electric Automation (China) Ltd. No.1386 Hongqiao Road, Mitsubishi Electric Automation Center, Changning District, Shanghai, China Tel : +86-21-2322-3030
Germany	Mitsubishi Electric Europe B.V. German Branch Gothaer Strasse 8, D-40880 Ratingen, Germany Tel : +49-2102-486-0	Taiwan	Setsuyo Enterprise Co., Ltd. 6F., No.105, Wugong 3rd Road, Wugu District, New Taipei City 24889, Taiwan, R.O.C. Tel : +886-2-2299-2499
UK	Mitsubishi Electric Europe B.V. UK Branch Travellers Lane, Hatfield, Hertfordshire, AL10 8XB, UK. Tel : +44-1707-27-6100	Korea	Mitsubishi Electric Automation Korea Co., Ltd. 3F, 1480-6, Gayang-Dong, Gangseo-Gu, Seoul, 157-200, Korea Tel : +82-2-3660-9530
Italy	Mitsubishi Electric Europe B.V. Italian Branch Viale Colleoni 7-20864 Agrate Brianza (Milano), Italy Tel : +39-039-60531	Singapore	Mitsubishi Electric Asia Pte, Ltd. Industrial Division 307, Alexandra Road, Mitsubishi Electric Building, Singapore, 159943 Tel : +65-6470-2308
Spain	Mitsubishi Electric Europe B.V. Spanish Branch Carretera de Rubi 76-80.AC.420, E-08190 Sant Cugat del Valles (Barcelona), Spain Tel : +34-93-565-3131	Thailand	Mitsubishi Electric Automation (Thailand) Co., Ltd. Bang-Chan Industrial Estate No.111 Soi Serithai 54, T.Kannayao, A.Kannayao, Bangkok 10230 Thailand Tel : +66-2906-3238
France	Mitsubishi Electric Europe B.V. French Branch 25, Boulevard des Bouvets, F-92741 Nanterre Cedex, France Tel : +33-1-5568-5568	Indonesia	P. T. Autoteknindo Sumber Makmur Muara Karang Selatan, Block A / Utara No.1 Kav. No. 11, Kawasan Industri Pergudangan, Jakarta-Utara 14440, P.O, Box 5045, Indonesia Tel : +62-21-663-0833
Czech Republic	Mitsubishi Electric Europe B.V.-o.s.Czech office Avenir Business Park, Radicka 751/113e, 158 00 Praha5, Czech Republic Tel : +420-251-551-470	India	Mitsubishi Electric India Pvt. Ltd. 2nd Floor, Tower A & B, Cyber Greens, DLF Cyber City, DLF Phase-III, Gurgaon-122002 Haryana, India Tel : +91-124-463-0300
Poland	Mitsubishi Electric Europe B.V. Polish Branch ul. Krakowska 50, 32-083 Balice, Poland Tel : +48-12-630-47-00	Australia	Mitsubishi Electric Australia Pty. Ltd. 348 Victoria Road PO BOX11, Rydalmere, N.S.W 2116, Australia Tel : +61-2-9684-7777
Russia	Mitsubishi Electric Europe B.V. Russian Branch St.Petersburg office Piskarevsky pr. 2, bld 2, lit "Sch", BC "Benua", office 720; 195027, St. Petersburg, Russia Tel : +7-812-633-3497		

MITSUBISHI ELECTRIC CORPORATION

HEAD OFFICE : TOKYO BUILDING, 2-7-3 MARUNOUCHI, CHYODA-KU, TOKYO 100-8310, JAPAN
NAGOYA WORKS : 1-14, YADA-MINAMI 5-CHOME, HIGASHI-KU, NAGOYA, JAPAN

When exported from Japan, this manual does not require application to the Ministry of Economy, Trade and Industry for service transaction permission.

Specifications subject to change without notice.