

# MITSUBISHI

A/D converter module type A68AD

User's Manual

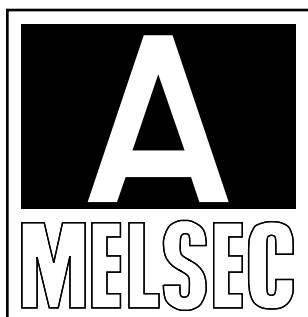
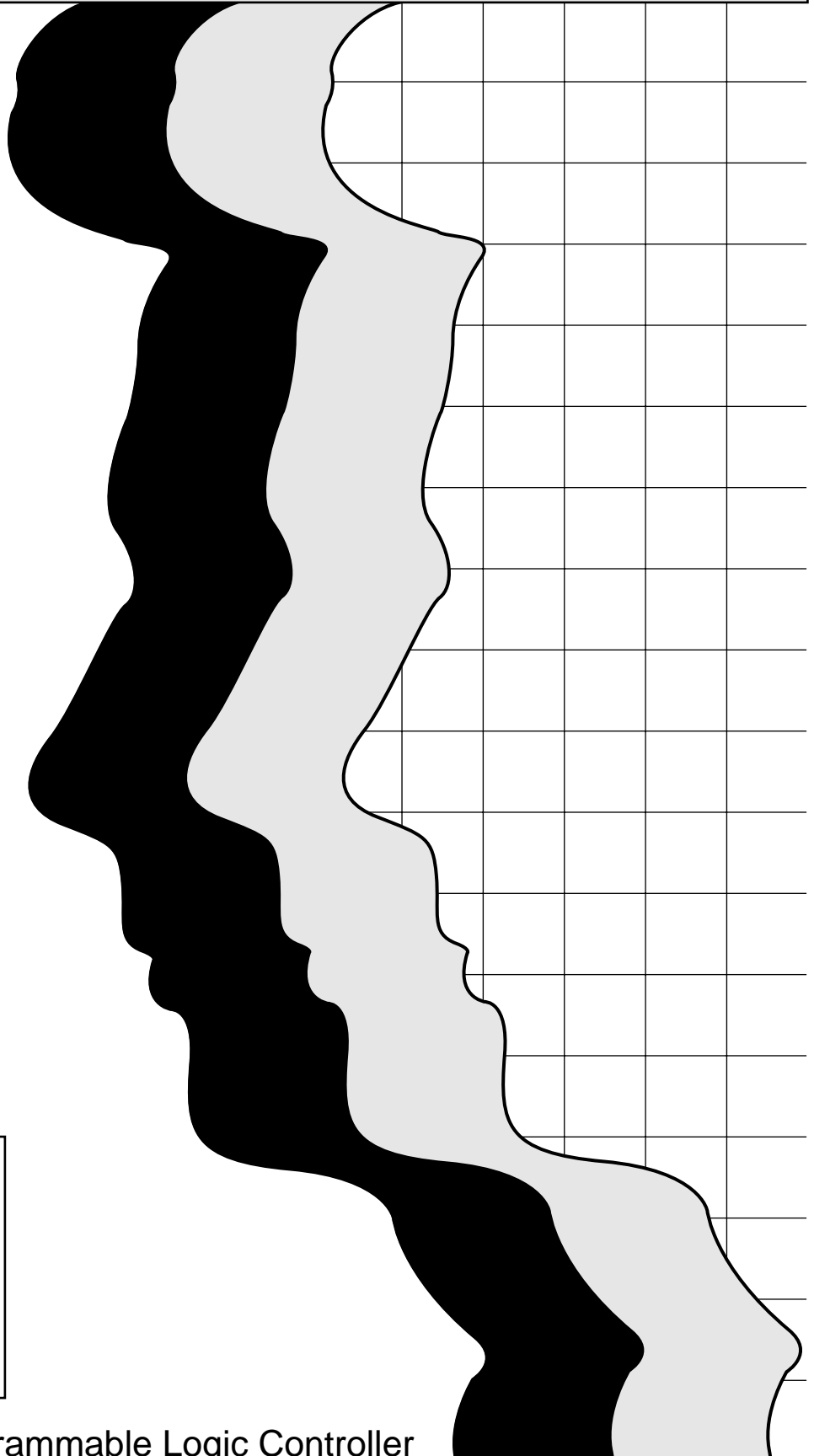

Mitsubishi Programmable Logic Controller

## ● SAFETY PRECAUTIONS ●

(Always read these instructions before using this equipment.)

Before using this product, please read this manual and the relevant manuals introduced in this manual carefully and pay full attention to safety to handle the product correctly.

The instructions given in this manual are concerned with this product. Refer to the User's Manual of the CPU module in use for details on the safety instructions for the programmable logic controller system.

In this manual, the safety instructions are ranked as "DANGER" and "CAUTION".



**DANGER**

Indicates that incorrect handling may cause hazardous conditions, resulting in death or severe injury.



**CAUTION**

Indicates that incorrect handling may cause hazardous conditions, resulting in medium or slight personal injury or physical damage.

Note that the  **CAUTION** level may lead to a serious consequence according to the circumstances. Always follow the instructions of both levels because they are important to personal safety.

Please save this manual to make it accessible when required and always forward it to the end user.

### [DESIGN PRECAUTIONS]

#### **CAUTION**

- Do not bunch the control wires or communication cables with the main circuit or power wires, or install them close to each other.  
They should be installed 100mm (3.94inch) or more from each other.  
Not doing so could result in noise that would cause erroneous operation.

### [INSTALLATION PRECAUTIONS]

#### **CAUTION**

- Use the PLC in an environment that meets the general specifications given in the User's Manual of the CPU module in use.  
Using this PLC in an environment outside the range of the general specifications could result in electric shock, fire, erroneous operation, and damage to or deterioration of the product.
- Securely insert the module fixing latch on the module bottom into the fixing holes on the base unit before mounting. Incorrect mounting of the module could lead to erroneous operation, faults or dropping.  
When using the PLC in the environment of much vibration, tighten the module with a screw.
- Tighten the screw in the specified torque range. Undertightening can cause a drop, short circuit or malfunction. Overtightening can cause a drop, short circuit or malfunction due to damage to the screw or module.
- Do not directly touch the module's conductive parts or electronic components.  
Touching the conductive parts could cause an operation failure or give damage to the module.

## [WIRING PRECAUTIONS]

### CAUTION

- Ground the FG terminal and ANALOG GND terminal with grounding dedicated for the PLC. Failure to observe this could lead to erroneous operation.
- When wiring in the PLC, be sure that it is done correctly by checking the product's rated voltage and the terminal layout. Connecting a power supply that is different from the rating or incorrectly wiring the product could result in fire or damage.
- Tightening the terminal screws with the specified torque.  
If the terminal screws are loose, it could result in short circuits, fire, or erroneous operation. Overtightening can cause a drop, short circuit or malfunction due to damage to the screw or module.
- Be sure there are no foreign substances such as sawdust or wiring debris inside the module. Such debris could cause fires, damage, or erroneous operation.

## [STARTUP AND MAINTENANCE PRECAUTIONS]

### CAUTION

- Do not touching the terminals with power on.  
Failure to observe this could lead to erroneous operation.
- Switch all phases of the external power supply off when cleaning the module or tightening the terminal screws.  
Not doing so can cause a module failure or malfunction.  
Undertightening can cause a drop, short circuit or malfunction. Overtightening can cause a drop, short circuit or malfunction due to damage to the screw or module.
- Do not disassemble or modify the module.  
Doing so could cause trouble, erroneous operation, injury, or fire.
- Switch all phases of the external power supply off before mounting or removing the module.  
If you do not switch off the external power supply, it will cause failure or malfunction of the module.
- Always make sure to touch the grounded metal to discharge the electricity charged in the body, etc., before touching the module.  
Failure to do so may cause a failure or malfunctions of the module.

## [DISPOSAL PRECAUTIONS]

### CAUTION

- When disposing of the product, handle it as industrial waste.

## REVISIONS

※The manual number is given on the bottom left of the back cover.

Print Date	*Manual Number	Revision
Nov., 1986	IB (NA) 66054-A	First edition
May., 1987	IB (NA) 66054-B	<div style="border: 1px solid black; padding: 2px; display: inline-block;">Correction</div> Page 4-2
Apr., 1989	IB (NA) 66054-C	<div style="border: 1px solid black; padding: 2px; display: inline-block;">Correction</div> CONTENTS, Page 1-1, 2-1, 2-2, 3-1, 3-2, 3-3, 3-4, 3-5, 3-11, 4-1, 4-2, 6-3, 8-2, 8-3, 8-4, 8-5, 8-6, 8-7, APP-1  <div style="border: 1px solid black; padding: 2px; display: inline-block;">Deletion</div> Section 2.4  "Instructions for Strategic Materials" added
May, 2000	IB (NA) 66054-D	<div style="border: 1px solid black; padding: 2px; display: inline-block;">Addition</div> WARRANTY  <div style="border: 1px solid black; padding: 2px; display: inline-block;">Part Addition</div> Section 3.2.2, 4.2  <div style="border: 1px solid black; padding: 2px; display: inline-block;">Correction</div> SAFETY PRECAUTIONS, Section 3.2.1, 4.1, 5.1.2
July, 2003	IB (NA) 66054-E	<div style="border: 1px solid black; padding: 2px; display: inline-block;">Correction</div> SAFETY PRECAUTIONS, Chapter1, Section 2.1, 2.2, 4.2, 4.3.2  <div style="border: 1px solid black; padding: 2px; display: inline-block;">Addition</div> Conformation to the EMC Directive and Low Voltage Instration

Japanese Manual Version IB-64572-L

This manual confers no industrial property rights or any rights of any other kind, nor does it confer any patent licenses. Mitsubishi Electric Corporation cannot be held responsible for any problems involving industrial property rights which may occur as a result of using the contents noted in this manual.

## INTRODUCTION

Thank you for choosing the Mitsubishi MELSEC-A Series of General Purpose Programmable Controllers. Please read this manual carefully so that the equipment is used to its optimum. A copy of this manual should be forwarded to the end User.

## CONTENTS

<b>1. GENERAL DESCRIPTION</b> .....	1-1
<b>2. SYSTEM CONFIGURATION</b> .....	2-1 ~ 2-2
2.1 Overall Configuration .....	2-1
2.2 Applicable System .....	2-2
2.3 Channel Isolation Information .....	2-2
<b>3. SPECIFICATIONS</b> .....	3-1 ~ 3-15
3.1 General Specifications .....	3-1
3.2 Performance Specifications .....	3-2
3.2.1 Performance specifications .....	3-2
3.2.2 I/O conversion characteristics .....	3-3
3.2.3 Digital I/O system .....	3-7
3.3 I/O List with Respect to Programmable Controller CPU .....	3-11
3.4 Buffer Memory .....	3-12
3.4.1 Assignment of buffer memory .....	3-12
3.4.2 Contents and data configuration of buffer memory .....	3-13
<b>4. HANDLING</b> .....	4-1 ~ 4-2
4.1 Handling Instructions .....	4-1
4.2 Nomenclature .....	4-2
<b>5. INSTALLATION</b> .....	5-1
5.1 Wiring .....	5-1
5.1.1 Wiring instructions .....	5-1
5.1.2 Unit connection example .....	5-1
<b>6. PROGRAMMING</b> .....	6-1 ~ 6-7
6.1 Initial Setting .....	6-1
6.2 Programming Instructions .....	6-3
6.2.1 Basic programs for read and write .....	6-3
6.2.2 Setting the number of channels .....	6-4
6.2.3 Setting of averaging time or averaging count .....	6-4
6.2.4 Averaging processing specification .....	6-4
6.2.5 Read of digital output value .....	6-5
6.2.6 Read and reset of write data error code .....	6-5
6.2.7 Application circuit examples .....	6-6

**7. TEST OPERATION AND CALIBRATION ..... 7-1 ~ 7-3**

- 7.1 Offset/Gain Setting ..... 7-1
- 7.2 Checks before Starting ..... 7-3

**8. TROUBLESHOOTING ..... 8-1 ~ 8-7**

- 8.1 Write Data Error Code List ..... 8-1
- 8.2 Troubleshooting ..... 8-2
  - 8.2.1 Troubleshooting flow chart ..... 8-2
  - 8.2.2 Flow chart used when "RUN" LED has flickered ..... 8-3
  - 8.2.3 Flow chart used when "RUN" LED has turned off ..... 8-4
  - 8.2.4 Flow chart used when digital output value cannot be read ..... 8-5
  - 8.2.5 Flow chart used when data, such as the number of channels,  
cannot be written ..... 8-7

**APPENDIX ..... APP-1**

- External View ..... APP-1

### Conformation to the EMC Directive and Low Voltage Instruction

For details on making Mitsubishi PLC conform to the EMC directive and low voltage instruction when installing it in your product, please see Chapter 3, "EMC Directive and Low Voltage Instruction" of the User's Manual (Hardware) of the PLC CPU to use.

The CE logo is printed on the rating plate on the main body of the PLC that conforms to the EMC directive and low voltage instruction.

By making this product conform to the EMC directive and low voltage instruction, it is not necessary to make those steps individually.

## 1. GENERAL DESCRIPTION

This User's Manual describes the specifications, handling, programming procedures, etc. for the A68AD analog-digital converter module (hereinafter referred to as "A68AD") which is used in combination with the MELSEC-A series CPU module.

The CPU types are generically labeled as follows in this User's Manual.

### (1) PLC CPU

A0J2(H)CPU  
A1CPU, A2CPU(S1), A3CPU  
A1NCP, A2NCP(S1), A3NCP  
A2ACPU(S1), A3ACPU  
A2UCPU(S1), A3UCPU, A4UCPU  
Q2ACPU(S1), Q3ACPU, Q4ACPU,  
A3HCP, A3MCP, K2ACPU

### (2) Building-block type CPU

A1CPU, A2CPU(S1), A3CPU  
A1NCP, A2NCP(S1), A3NCP  
A2ACPU(S1), A3ACPU  
A2UCPU(S1), A3UCPU, A4UCPU  
Q2ACPU(S1), Q3ACPU, Q4ACPU  
A3HCP, A3MCP, K2ACPU

### (3) Compact-type CPU

A0J2(H)CPU

### (4) ACP

A0J2(H)CPU  
A1CPU, A2CPU(S1), A3CPU  
A1NCP, A2NCP(S1), A3NCP  
A2ACPU(S1), A3ACPU  
A2UCPU(S1), A3UCPU, A4UCPU  
Q2ACPU(S1), Q3ACPU, Q4ACPU  
A3HCP, A3MCP

#### POINT

In this manual, the I/O assignment numbers of the A68AD as viewed from the PLC CPU assume that a building block type CPU is used and the A68AD is mounted on slot No. 0 of the main base unit. When mounting the module on other than slot No. 0 or when using the A0J2CPU, determine the assignment numbers of the A68AD in the I/O assignment method of the Programming Manual.



### 2. SYSTEM CONFIGURATION

#### 2.1 Overall Configuration

The overall configuration is shown in Fig. 2.1.

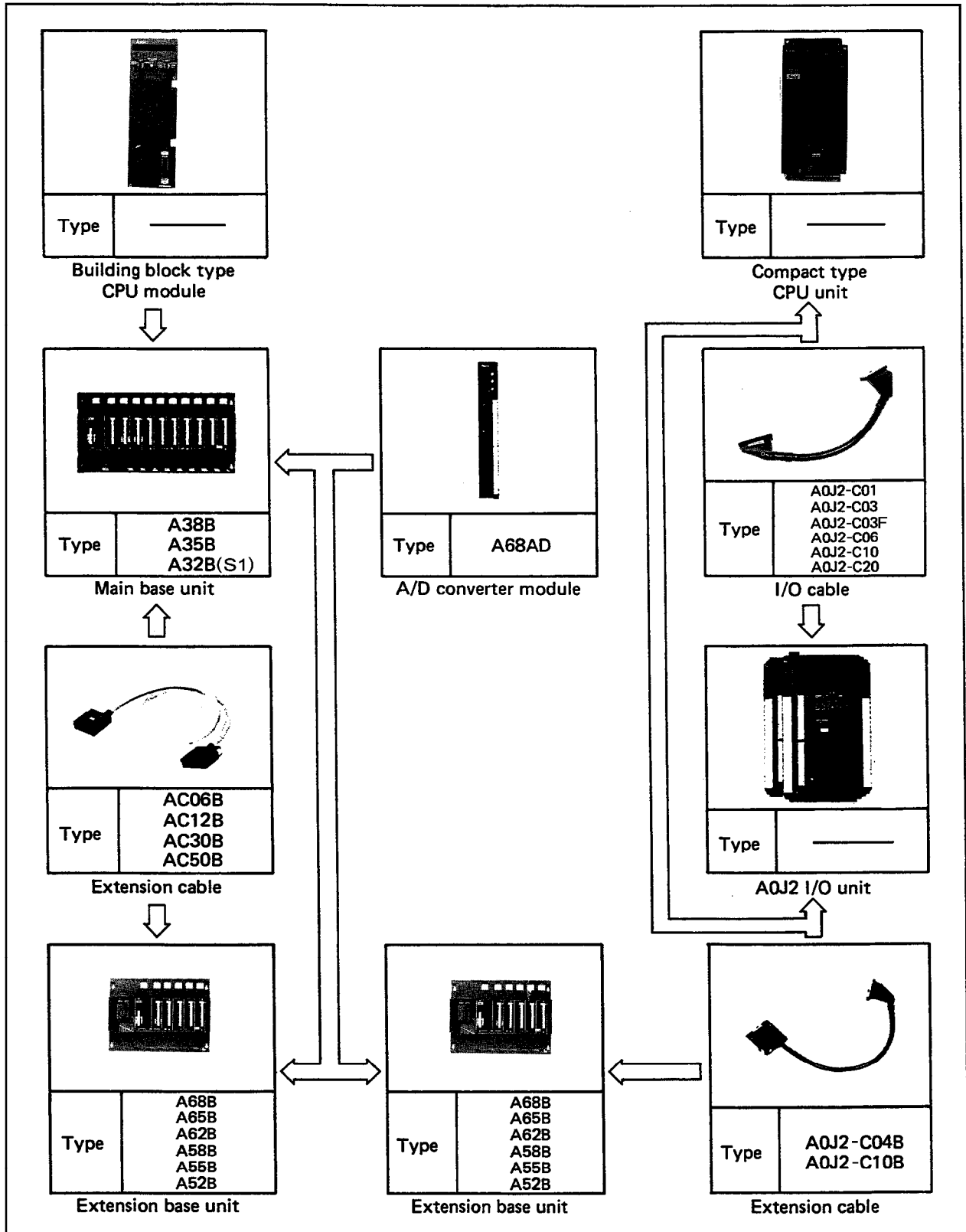

Fig. 2.1 Overall Configuration Diagram

## 2. SYSTEM CONFIGURATION



### 2.2 Applicable System

The A68AD can be used with the following CPU modules:

Applicable models	A0J2CPU A0J2HCPU A1CPU A2CPU A2CPU-S1 A3CPU	A1NCPUP A2NCPUP A2NCPUP-S1 A3NCPUP A2ACPU A2ACPU-S1	A3ACPU A2UCPU A2UCPU-S1 A3UCPU A4UCPU Q2ACPU	Q2ACPU-S1 Q3ACPU Q4ACPU A3HCPU A3MCPUP K2ACPU
-------------------	--	--	---	--

The A68AD can be loaded into any slot of a base unit with the exceptions given below:

- (1) Avoid loading the A68AD into an extension base without a power supply module because power capacity may be insufficient. See CPU User's Manual for power supply selection etc.
- (2) For a data link system, the CPU must be one of the following types:

Master station	A0J2HCPUP21/R21 A2CPUP21/R21-S1 A2NCPUP21(S3)/R21 A2ACPUP21(S3)/R21 A2UCPU A4UCPU Q3ACPU A3MCPUP21/R21	A1CPUP21/R21 A3CPUP21 A2NCPUP21-S1(S4)/R21-S1 A2ACPUP21-S1(S4)/R21-S1 A2UCPU-S1 Q2ACPU Q4ACPU	A2CPU21/R21 A1NCPUP21(S3)/R21 A3NCPUP21(S3)/R21 A3ACPUP21(S3)/R21 A3UCPU Q2ACPU-S1 A3HCPUP21/R21
Master station	A0J2CPUP23/R23 A0J2HCPUP21/R21 A2CPUP21/R21-S1 A2NCPUP21(S3)/R21 A2ACPUP21(S3)/R21 A2UCPU A4UCPU Q3ACPU A3MCPUP21/R21	A1CPUP21/R21 A3CPUP21 A2NCPUP21-S1(S4)/R21-S1 A2ACPUP21-S1(S4)/R21-S1 A2UCPU-S1 Q2ACPU Q4ACPU	A2CPU21/R21 A1NCPUP21(S3)/R21 A3NCPUP21(S3)/R21 A3ACPUP21(S3)/R21 A3UCPU Q2ACPU-S1 A3HCPUP21/R21

For processing time with the A68AD in a data link system, refer to the Data link unit User's Manual.

- (3) When use with A3CPU(P21/R21), cannot install at the final slot of 7th extension base.

### 2.3 Channel Isolation Information

The only isolation on the A68AD is photocoupler insulation between the output terminals and the PC power supply. The individual channels are not isolated.

If channel isolation is necessary, two or more A68AD modules must be used.

### 3. SPECIFICATIONS

This chapter describes the general specifications and performance specifications of the A68AD.

#### 3.1 General Specifications

The general specifications of A68AD are indicated in Table 3.1.

Item	Specifications				
Operating ambient temperature	0 to 55°C				
Storage ambient temperature	-20 to 75°C				
Operating ambient humidity	10 to 90%RH, no condensation				
Storage ambient humidity	10 to 90%RH, no condensation				
Vibration resistance	Conforms *1 to JIS C0911	Frequency	Acceleration	Amplitude	Sweep Count
		10 to 55Hz	—	0.075mm	10 times
		55 to 150Hz	1g	—	*(1 octave/minute)
Shock resistance	Conforms to JIS C 0912 (10g x 3 times in 3 directions)				
Noise durability	By noise simulator 1500Vpp noise voltage, 1μs noise width and 25 to 60Hz noise frequency				
Dielectric withstand voltage	500V AC for 1 minute across batch of DC external terminals and ground				
Insulation resistance	5MΩ or larger by 500V DC insulation resistance tester across batch of AC external terminals and ground				
Grounding	Class 3 grounding				
Operating ambience	To be free from corrosive gases. Dust should be minimal.				
Cooling method	Self-cooling				

Table 3.1 General Specifications

#### REMARKS

One octave marked \* indicates a change from the initial frequency to double or half frequency. For example, any of the changes from 10Hz to 20Hz, from 20Hz to 40Hz, from 40Hz to 20Hz, and 20Hz to 10Hz are referred to as one octave.

\*1 JIS : Japanese Industrial Standard

### 3. SPECIFICATIONS



#### 3.2 Performance Specifications

##### 3.2.1 Specifications

Item	Specifications												
Analog input	Selection depends on input terminals. Voltage: -10 to 0 to +10V DC (Input resistance: Hardware version K and above: 1MΩ Hardware version J and below: 30kΩ) Current: + 4 to +20mA DC (Input resistance: 250Ω)* <sup>1</sup> -20 to 0 to +20mA can also be used for current input.												
Digital output	A CPU: 16-bit, signed binary (-2048 to +2047) Refer to section 3.4 for details.												
I/O characteristics	<table border="1"> <thead> <tr> <th>Analog Input</th> <th>Digital Output</th> </tr> </thead> <tbody> <tr> <td>+10V</td> <td>+2000</td> </tr> <tr> <td>+5V or +20mA</td> <td>+1000</td> </tr> <tr> <td>0V or +4mA</td> <td>±0</td> </tr> <tr> <td>-5V or -12mA</td> <td>-1000</td> </tr> <tr> <td>-10V</td> <td>-2000</td> </tr> </tbody> </table> <p>Refer to section 3.2.2 for details.</p>	Analog Input	Digital Output	+10V	+2000	+5V or +20mA	+1000	0V or +4mA	±0	-5V or -12mA	-1000	-10V	-2000
Analog Input	Digital Output												
+10V	+2000												
+5V or +20mA	+1000												
0V or +4mA	±0												
-5V or -12mA	-1000												
-10V	-2000												
Maximum resolution	Voltage: 5mV (1/2000) Current: 20μA (1/1000)												
Overall accuracy* <sup>2</sup>	±1% (±20)												
Maximum conversion speed	Maximum 2.5ms/channel												
Absolute maximum input	Voltage: ±15V Current: ±30mA												
Number of analog input points	8 channels/module												
Insulation method	Photocoupler insulation between output terminals and PC power (Non-insulated between channels)												
Number of I/O points	Special 32 points												
Connection terminal	38-point terminal block												
Applicable wire size	0.75 to 2mm <sup>2</sup> (Applicable tightening torque: 39 to 59N·cm)												
Applicable solderless terminal	V1.25-3, V1.25-YS3A, V2-S3, V2-YS3A												
Internal current consumption (5V DC)	Hardware version K and above: 0.39A Hardware version J and below : 0.9A												
Weight	Hardware version K and above: 0.3kg (0.66lb) Hardware version J and below : 0.6kg (1.32lb)												

**Table 3.2 Performances Specifications**

\*1. Confirm the module hardware version with the label attached to the front of the module.

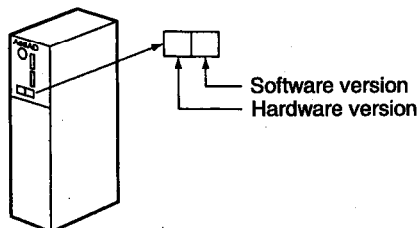

\*2. This is the accuracy in respect to the maximum digital output value (+2000).  
The same value (+2000) applies for the current input and voltage input.

**POINT**

Analog input allowed for maximum resolution and overall accuracy, is from -10 to 0 to +10V or from -20 to 0 to +20mA.

#### 3.2.2 I/O conversion characteristics

I/O conversion characteristics are dictated by the offset value and gain value set in test mode. Fig. 3.1 shows an example for voltage input.

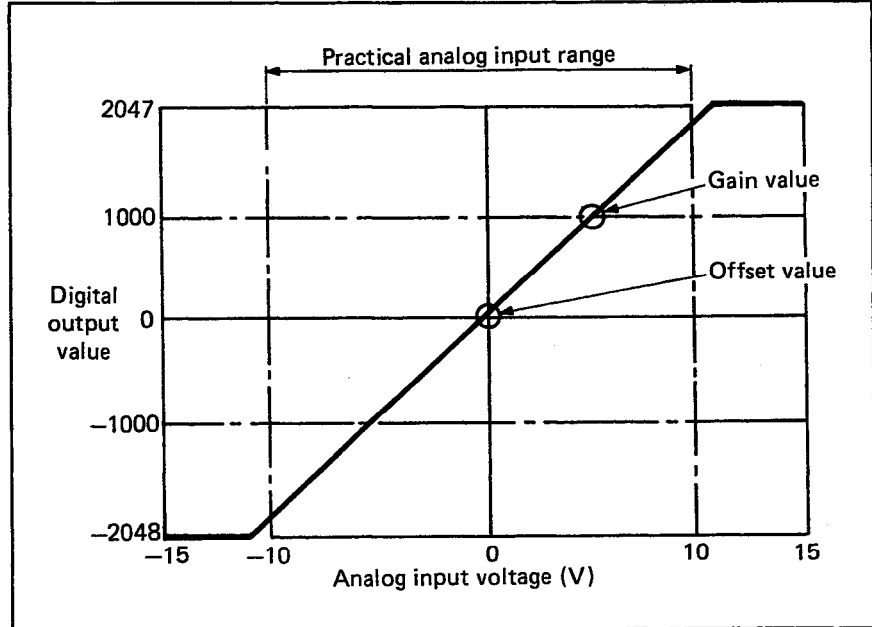

Fig. 3.1 I/O Conversion Characteristics

#### REMARKS

1. The offset value is the analog input (voltage or current) value at which the digital output value is 0. Set the offset value in test mode.
2. The gain value is the analog input (voltage or current) value at which the digital output value is 1000. Set the gain value in test mode.

#### (1) Voltage input characteristic

Fig. 3.2 shows the voltage characteristics for three different offset/gain combinations.

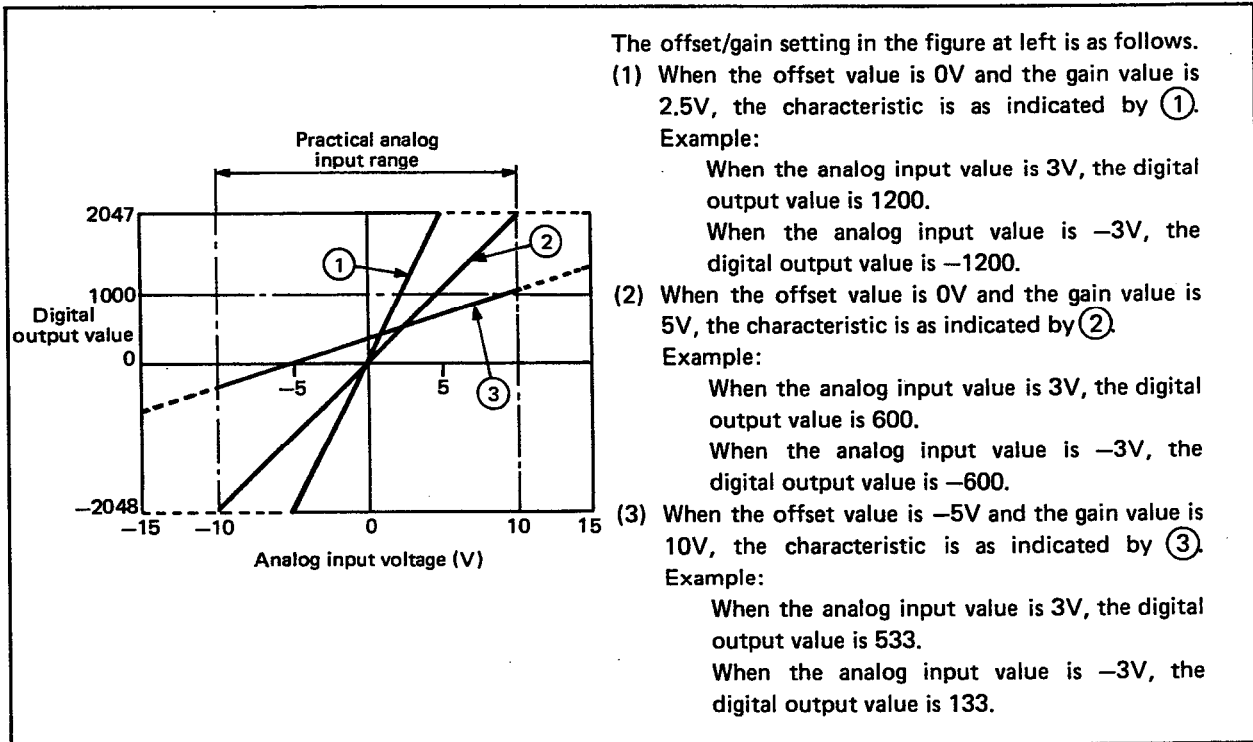

The offset/gain setting in the figure at left is as follows.

- (1) When the offset value is 0V and the gain value is 2.5V, the characteristic is as indicated by ①.

Example:

When the analog input value is 3V, the digital output value is 1200.

When the analog input value is -3V, the digital output value is -1200.

- (2) When the offset value is 0V and the gain value is 5V, the characteristic is as indicated by ②.

Example:

When the analog input value is 3V, the digital output value is 600.

When the analog input value is -3V, the digital output value is -600.

- (3) When the offset value is -5V and the gain value is 10V, the characteristic is as indicated by ③.

Example:

When the analog input value is 3V, the digital output value is 533.

When the analog input value is -3V, the digital output value is 133.

Fig. 3.2 Voltage Input Characteristic

#### POINT

- When the input voltage is in the range from -10 to 0 to +10V, the maximum resolution and overall accuracy are within the quoted range of performance specifications. However, if this range is exceeded, resolution and accuracy will be impaired.
- If an analog input corresponding to a digital output value of more than +2047 or less than -2048 is applied, the digital output value will not exceed +2047 or -2048.
- Do not apply  $\pm 15V$  or more. This will damage the module.
- In offset/gain setting, the offset value should always be less than the gain value. If the offset value is greater than or equal to the gain value, the digital output value will be unpredictable.

#### (2) Current input characteristic

Fig. 3.3 shows the current characteristics for two different offset/gain combinations.

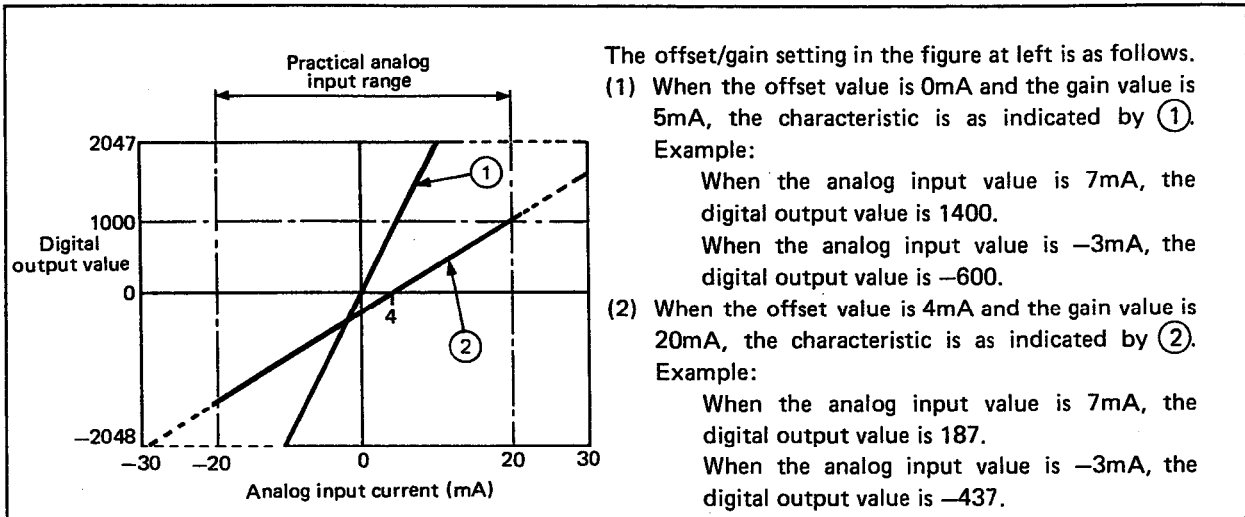

Fig. 3.3 Current Input Characteristic

#### POINT

1. When the input current is in the range from -20 to 0 to +20mA, the maximum resolution and overall accuracy are within the quoted range of performance specifications. However, if this range is exceeded, resolution and accuracy will be impaired.
2. If an analog input, corresponding to a digital output value of more than +2047 or less than -2048 is applied, the digital output value will not exceed +2047 or -2048.
3. Do not apply ±30mA or more. This will damage the module.
4. In offset/gain setting, the offset value should always be less than the gain value. If the offset value is greater than or equal to the gain value, the digital output value will be unpredictable.

#### (3) Relation between offset/gain setting and digital output value

The maximum resolution of the A68AD is 5mV in voltage and 20μA in current. Maximum resolution may be found using the following expression:

$$\frac{(\text{Gain value}) - (\text{offset value})}{1000} < (\text{maximum resolution})$$

Fig. 3.4 and 3.5 show the relation between the offset/gain setting and the digital output value for the offset/gain settings in Fig. 3.2 and 3.3.

### 3. SPECIFICATIONS

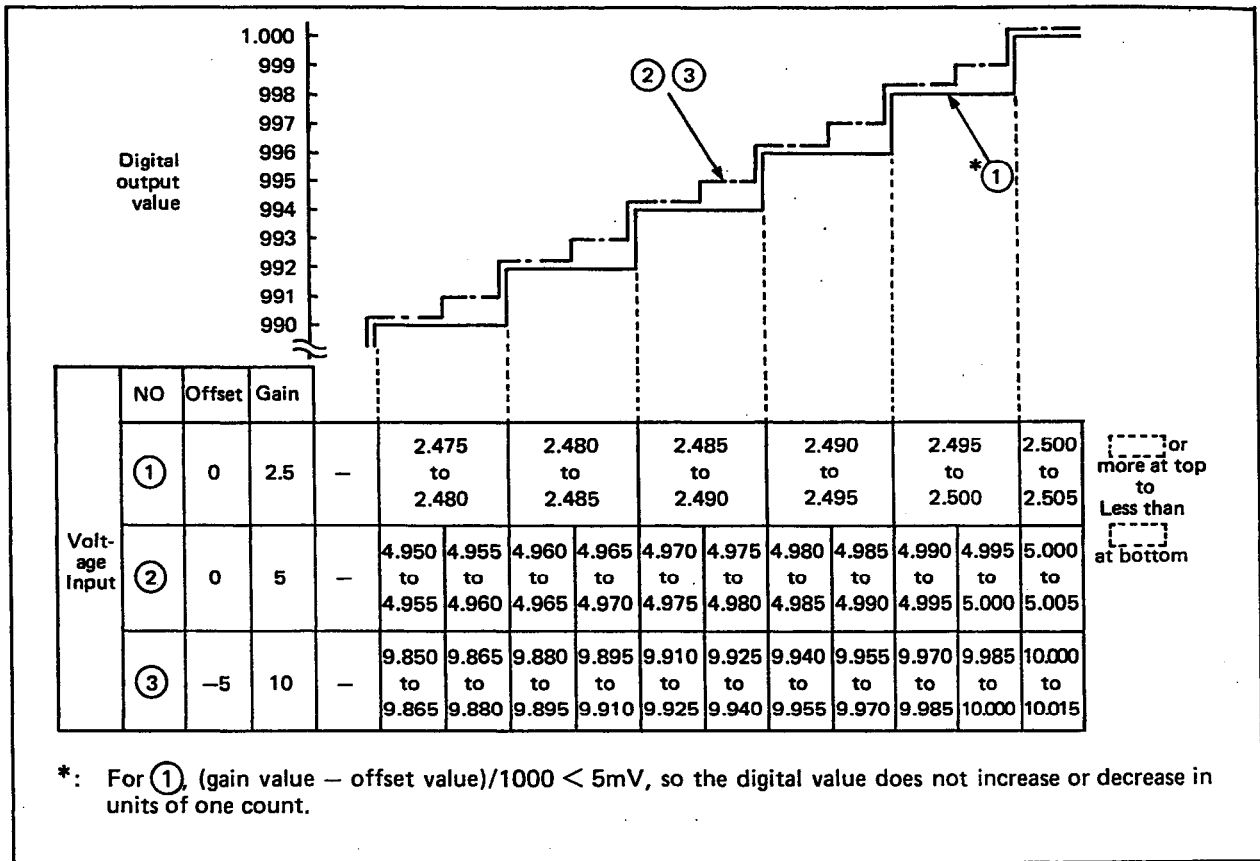

Fig. 3.4 Voltage Input and Digital Output Value

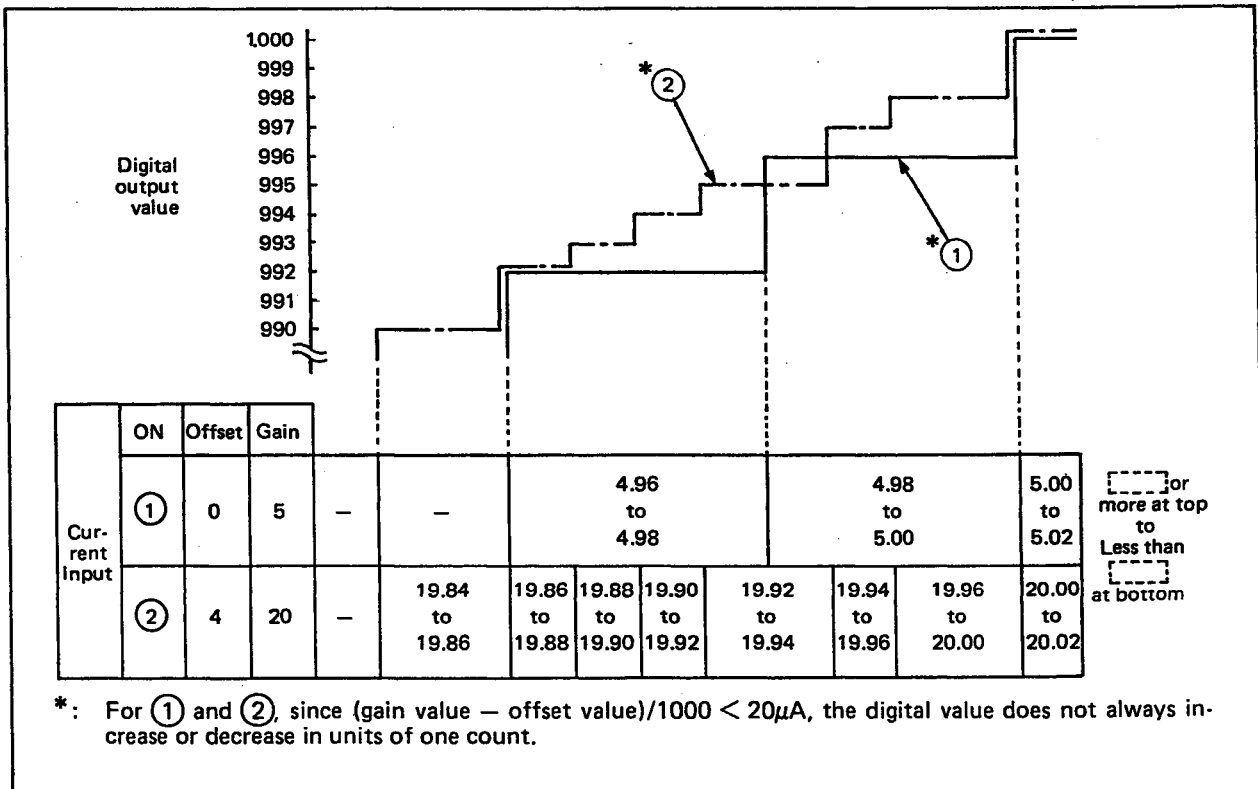

Fig. 3.5 Current Input and Digital Output Value



#### (4) Overall accuracy

The overall accuracy is the accuracy in respect to the maximum digital output value.

Even if the input characteristics are changed by changing the offset/gain settings, the overall accuracy will not change and will be kept within the range of the performance specifications. The overall accuracies of the power/current input characteristics are shown in Fig. 3.6 and Fig. 3.7.

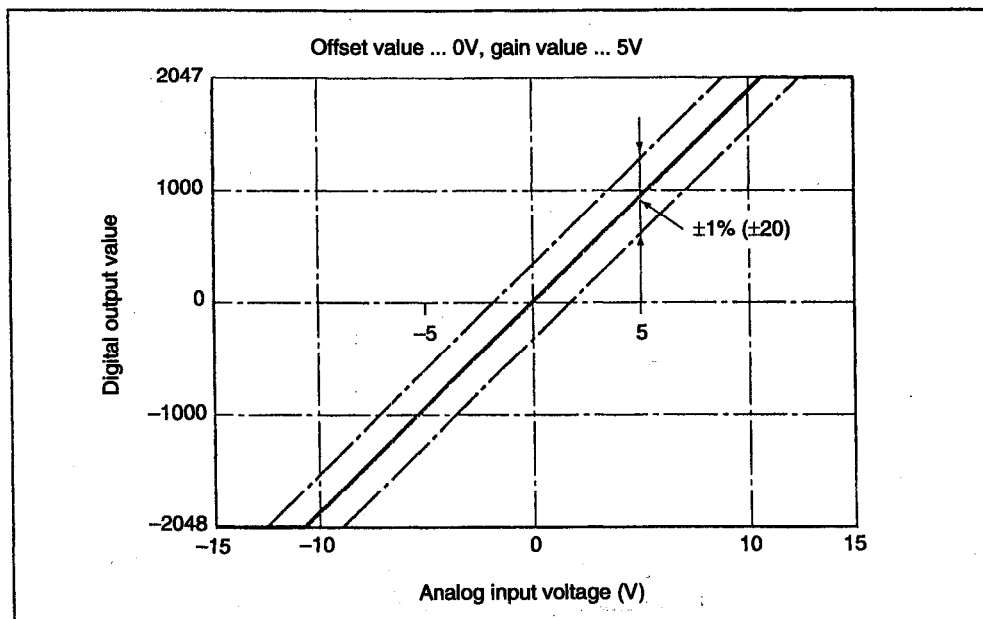

**Fig. 3.6 Overall accuracy of voltage input characteristics**

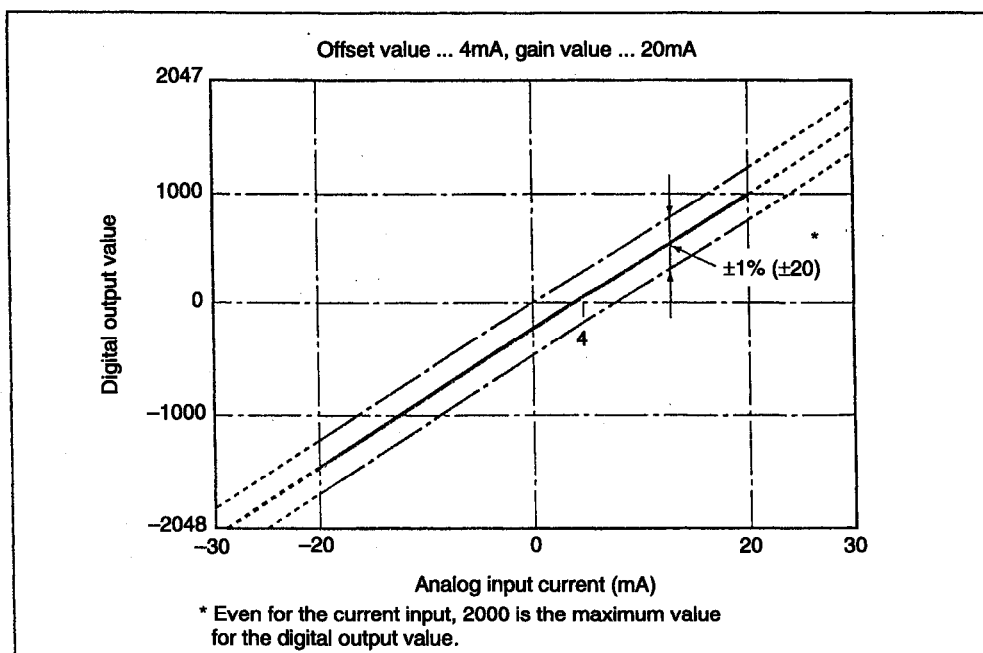

**Fig. 3.7 Overall accuracy of current input characteristics**

#### 3.2.3 Digital I/O system

The digital output value of the A68AD is determined by the following:

(1) I/O conversion characteristics:

- Offset value
- Gain value

The digital output value depends on the offset value and gain value which have been set in test mode.

(2) A/D conversion system:

- Sampling processing
- Averaging processing
  - Averaging processing in terms of count. . . . . 1 to 4000 times
  - Averaging processing in terms of time. . . . . 20 to 10000ms

1) Sampling processing

The analog input values are converted to digital output values one by one and the digital output values are stored in the buffer memory.

2) Averaging processing

The A68AD makes the A/D conversion for any channels to which averaging processing has been specified from the programmable controller CPU. Using a preset count or a preset period of time, an average is calculated (excluding the maximum value and the minimum value,) and stored to the buffer memory. If the processing count is specified as two or less, sampling processing is applied.

**POINT**

The A68AD may sample data in any one of three ways. These sampling methods can be applied separately to any channel. The sampling process is controlled by the A68AD's own CPU, but must be specified from the programmable controller CPU. (This is fully explained in section 3.4.1)

**Method 1**

**Sampling Processing:** This is the most commonly used sampling procedure. As the A68AD's CPU scans each channel, the value appearing at that instant is written to the buffer memory as a digital value. The timing of this sampling depends on the number of channels used, and may be found from the following expression:

$$\left( \begin{array}{c} \text{Processing} \\ \text{time} \end{array} \right) = \left( \begin{array}{c} \text{Number of channels} \\ \text{used} \end{array} \right) \times 2.5 \text{ (ms/channel)}$$

(Where the maximum conversion speed is taken as 2.5ms/channel)

**Example 1:** Number of channels = 5

$$\text{Processing time} = 5 \times 2.5\text{ms} = 12.5\text{ms}$$

**Method 2**

**Averaging processing by specifying time:** In this case the CPU takes a number of samples of the data at each channel and then calculates the average value over the specified time period. The number of samples taken depends on the number of channels and the time setting. It is calculated as follows:

$$\left( \begin{array}{c} \text{Processing count} \end{array} \right) = \frac{\text{(Time setting)}}{\text{(Number of channels)} \times 2.5\text{ms}} \quad \text{--(I)}$$

**Example 2:** Time setting = 1000ms, 4 channels

$$\left( \begin{array}{c} \text{Processing count} \end{array} \right) = \frac{1000}{4 \times 2.5} = 100 \text{ samples.}$$

(Where maximum conversion speed = 2.5ms/channel)

**Method 3**

**Averaging processing by specifying a number of counts:** This is similar to method 2 except that in this case the number of samples for the averaging process is specified. The processing time may be found from the following expression:

$$\left( \text{Processing time} \right) = \left( \text{Count setting} \right) \times \left( \text{Number of channels} \right) \times 2.5\text{ms}$$

Example 3: Count setting = 500, 4 channels

$$\left( \text{Processing time} \right) = 500 \times 4 \times 2.5 = 500\text{ms} \quad \text{---(II)}$$

(Where maximum conversion speed = 2.5ms/channel)

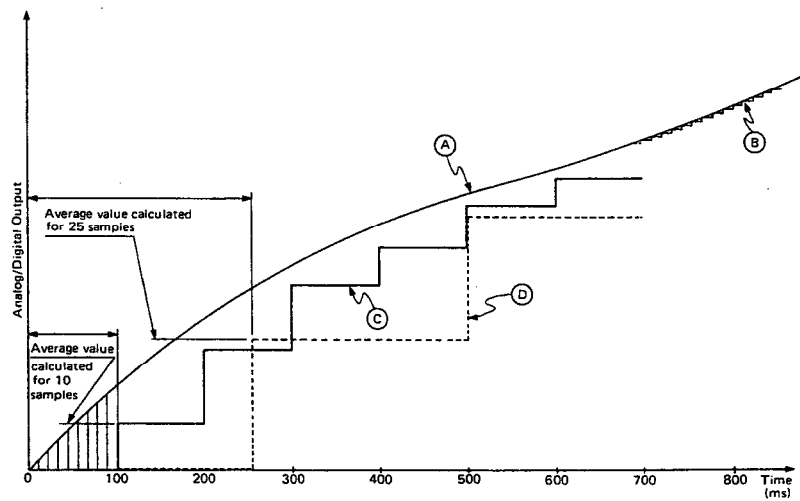

Fig. 3.6

Graph showing variations between output values for different sampling methods.

Referring to the graph in Fig. 3.6

Trace (A) represents a steadily rising analog input signal.

Trace (B) represents the digital output obtained when method 1, sampling processing, is used. In this case the output value would be susceptible to variations due to any noise present on the analog signal.

Trace (C) represents the digital output obtained when time based averaging is used. In this case the number of channels was taken as 4 and the sampling time as 100ms.

Hence the processing count (from equation I) is:

$$\frac{100}{4 \times 2.5} = 10 \text{ samples}$$

10 samples are therefore taken every 100ms and an average calculated. This average is then output as a digital value while the CPU takes the next 10 samples.

Note that the allowable time setting range is 20 → 10000ms which is equivalent to 2 → 1000 samples (with 4 channels).

Trace **(D)** represents the digital output obtained when count based averaging is used.

Again, the number of channels was taken as 4, the count setting was 25, the processing time, from equation II is

$$25 \times 4 \times 2.5 = 250\text{ms}$$

One sample is therefore taken every 10ms, and after 25 samples have been taken, the average value is used for the digital output while the next 250 are being sampled.

Note that the allowable count setting range is 1 → 4000 which is equivalent to 40 → 40000ms (with 4 channels).

#### 3.3 I/O List with Respect to Programmable Controller CPU

The I/O signals of the A68AD with respect to a programmable controller CPU are as indicated below. Numbers for X and Y are determined by the slot occupied by the A68AD and the number of points of the other I/O units.

The I/O numbers indicated below are used when the A68AD module is loaded into slot No. 0 of the main base unit.

- (1) Input signals with respect to programmable controller CPU, 32 points from X0 to 1F.

Input Signal	Description
X0	Watch dog timer error Turns on if a watch dog timer error occurs in the A68AD.
X1	A/D conversion ready (1) Turns on when A/D conversion is ready (not in test mode) after the power is turned on or the programmable controller CPU is reset. Turns off in test mode. (2) Used as an interlock when read or write is performed from the programmable controller CPU to the A68AD.
X2 to X1F	Not used

#### REMARKS

A/D conversion ready indicates that a digital output value has been stored into the buffer memory after the A/D conversion of all eight channels has been completed.

- (2) Output signals with respect to programmable controller CPU, 32 points from Y0 to 1F.

Output Signal	Description
Y0 to Y1F	Not used

#### IMPORTANT

Outputs Y0 to Y1F are reserved, they should not be used in the sequence program.

If the A68AD is used in a remote I/O rack, however, inputs Y0E and Y0F may be set and reset in the sequence program to allow "hand shaking" with the CPU.

#### 3.4 Buffer Memory

The A68AD is equipped with a buffer memory (which is not battery backed) for the communication of data with a programmable controller CPU. Explanation will be given for the assignment and data configuration of this buffer memory.

For the read and write operation procedures by the sequence program, refer to Chapter 6 (page 6-1).

##### 3.4.1 Assignment of buffer memory

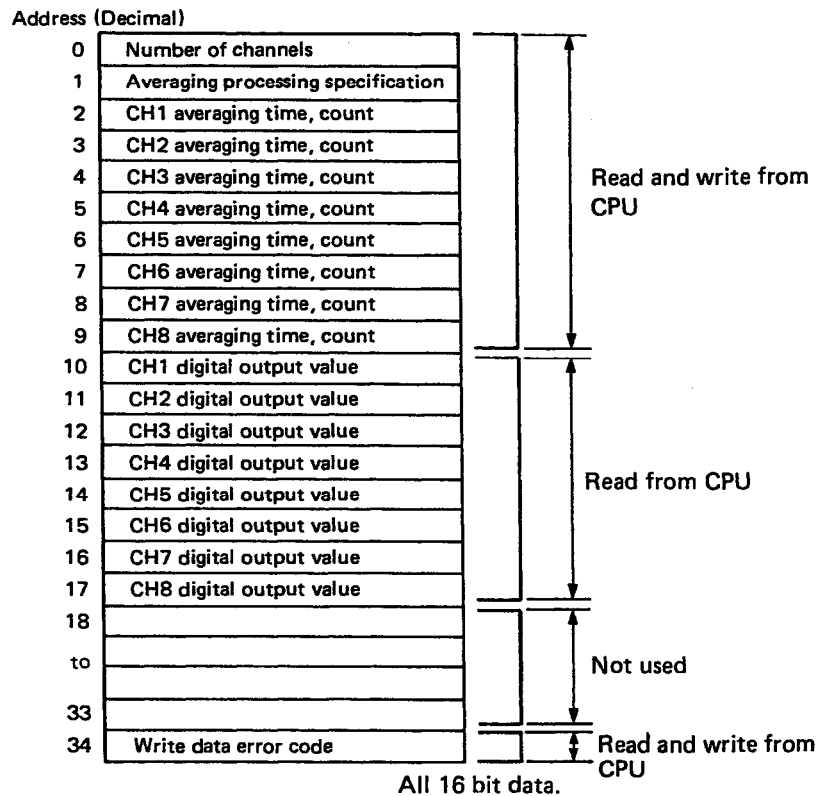

**POINT**

The addresses 10 to 33 of buffer memory are areas exclusively used for reading from a programmable controller CPU. Writing to these addresses will cause mis operation.

#### 3.4.2 Contents and data configuration of buffer memory

This section describes the contents and data configuration of buffer memory for each item indicated in Section 3.4.1 (page 3-12).

##### (1) Number of channels (Address 0)

- a) At power-on, the number of channels is set to 8.
- b) In order to reduce sampling time, the number of channels can be changed by in the sequence program. (For details, refer to Section 6.2.2 on page 6-4)

Example:	CH1	Used	}	By setting the number of channels to 4, the sampling time is changed to 2.5ms x 4 = 10ms.
	CH2	Vacant		
	CH3	Used		
	CH4	Used		
	CH5	Vacant		
	CH6	Vacant		
	CH7	Vacant		
	CH8	Vacant		

**POINT**

1. Although the number of channels at power-on is set inside the A68AD, it is not written to address 0 of the buffer memory.
2. When 0 is written for the number of channels, the A68AD regards the number of channels as 8 when performing A/D conversion processing.
3. When a number of channels other than 0 to 8 is written, setting error occurs and the buffer memory is rewritten. However, the A68AD performs A/D conversion processing for the number of channels set previously.

##### (2) Averaging processing specification (Address 1)

- a) When the power is turned on and the A/D conversion ready signal of A68AD is on, all channels are set to sampling processing.
- b) For selection of sampling processing or averaging processing use address 1 of the buffer memory.

B15	B14	B13	B12	B11	B10	B9	B8	B7	B6	B5	B4	B3	B2	B1	B0
CH8	CH7	CH6	CH5	CH4	CH3	CH2	CH1	CH8	CH7	CH6	CH5	CH4	CH3	CH2	CH1

Specification of channel for which averaging processing will be performed

- 1: Averaging processing
- 0: Sampling processing

Specification of time/count

- 1: Time averaging
- 0: Count averaging



**POINT**

When averaging processing is not specified, sampling processing is set without regard to the specification of time/count.

(3) Averaging time, averaging count (Addresses 2 to 9)

- a) At power-on, the averaging time and averaging count are set to 0.
- b) The setting ranges are as indicated below:

Averaging processing in terms of count: 1 to 4000 times  
 Averaging processing in terms of time: 20 to 10000ms

**POINT**

If a value outside the above range has been written, setting error occurs and the buffer memory is rewritten. However, the A68AD performs A/D conversion processing at the averaging time or count previously set.

(4) Digital output value (Addresses 10 to 17)

The digital output value is expressed in 16-bit, signed binary within the range from -2048 to +2047.

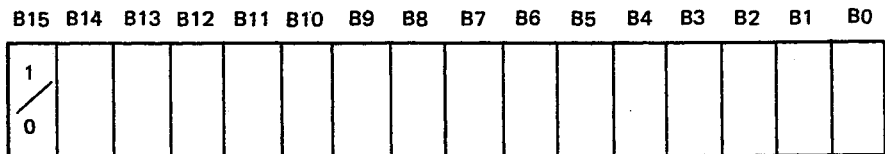

B11 to B14 change to 1 when the sign is negative (1 at B15) and to 0 when it is positive (0 at B15).  
 (A negative digital value is expressed in 2's complement.)

Sign bit  
 1: Negative  
 0: Positive

(5) Write data error code (Address 34)

- a) When data is read from the programmable controller CPU, the A68AD makes a data range check for the number of channels used once only. When one of the values is outside the range, the A68AD sets an error code in 16-bit binary. For details of error codes, refer to Section 8.1 (page 8-1).
- b) To reset an error code, write 0 from the programmable controller CPU.
- c) When several error codes have occurred, the data error code, which has been detected by the A68AD first, is stored. The other errors are not stored.
- d) If an error is reset without remedying the error, the data error code is set to 0 and the RUN LED of A68AD stops flickering (Section 4.2 on page 4-2).

### 4. HANDLING

This chapter describes the handling instructions, nomenclature, maintenance, and inspection of the A68AD.

#### 4.1 Handling Instructions

- (1) Protect the A68AD and its terminal block from impact.
- (2) Do not touch or remove the printed circuit board from the case.
- (3) When wiring, ensure that no wire offcuts enter the module and remove any that do enter.
- (4) Tighten terminal screws as specified below.

Screw	Tightening Torque Range (N·cm)
I/O terminal block terminal screw (M3 screw)	39 to 59
I/O terminal block mounting screw (M4 screw)	78 to 118

- (5) To load the module onto the base, press the module against the base so that the hook is securely locked. To unload the module, push the catch on the top of the module, and after the hook is disengaged from the base, pull the module toward you.

# 4. HANDLING



## 4.2 Nomenclature

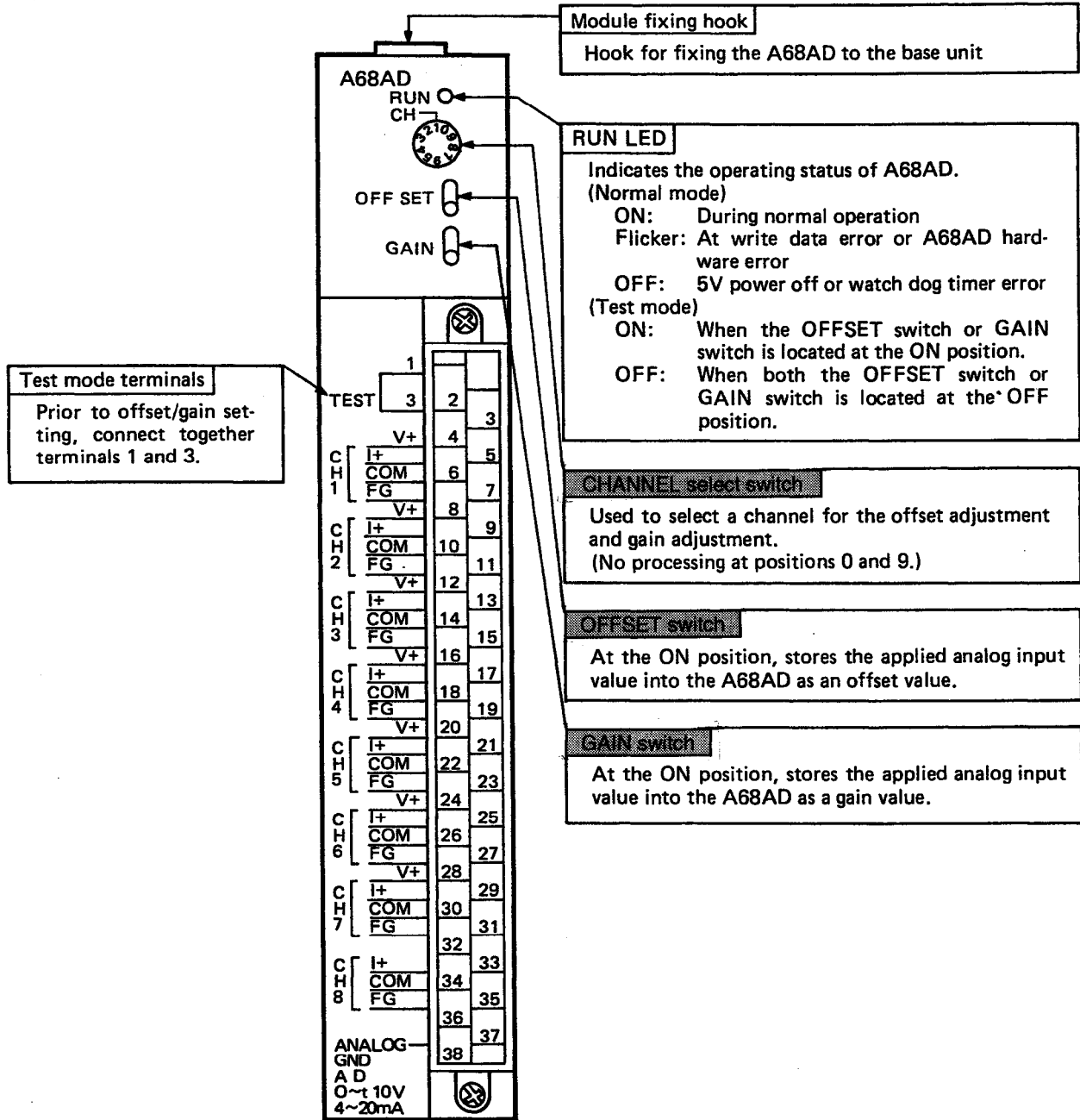

Switches marked are valid only in test mode. For details, refer to Section 7.1 (page 7-1).

Terminal No.	Signal name	Terminal No.	Signal name	Terminal No.	Signal name
1	TEST	13	V+	25	V+
2	Vacancy	14	I+	26	I+
3	TEST	15	COM	27	COM
4	Vacancy	16	FG	28	FG
5	V+	17	V+	29	V+
6	CH1 I+	18	I+	30	I+
7	CH1 COM	19	COM	31	COM
8	CH1 FG	20	FG	32	FG
9	V+	21	V+	33	V+
10	CH2 I+	22	I+	34	I+
11	CH2 COM	23	COM	35	COM
12	CH2 FG	24	FG	36	FG
				37	Vacancy
				38	Vacancy

## 5. INSTALLATION

### 5.1 Wiring

#### 5.1.1 Wiring instructions

Protect external wiring against noise with the following precautions:

- (1) Separate AC and DC wiring.
- (2) Separate main circuit and/or high voltage wiring from control and signal wiring.
- (3) Where applicable, ground the shielding of all wires to a common ground point.

#### 5.1.2 Unit connection example

##### (1) Voltage input

Signal source: 0 to  $\pm 10V$

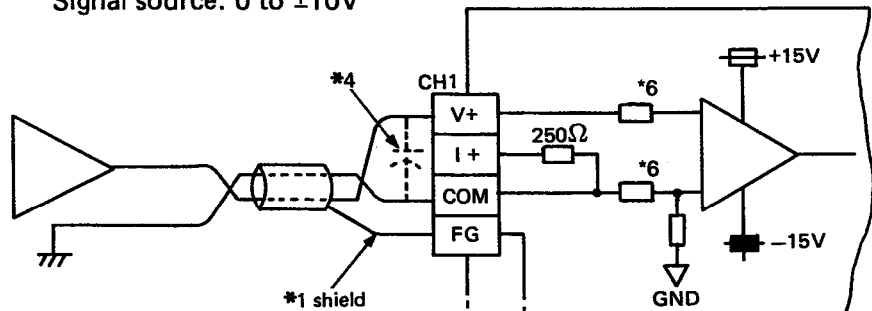

##### (2) Current input

Signal source: 0 to  $\pm 20mA$

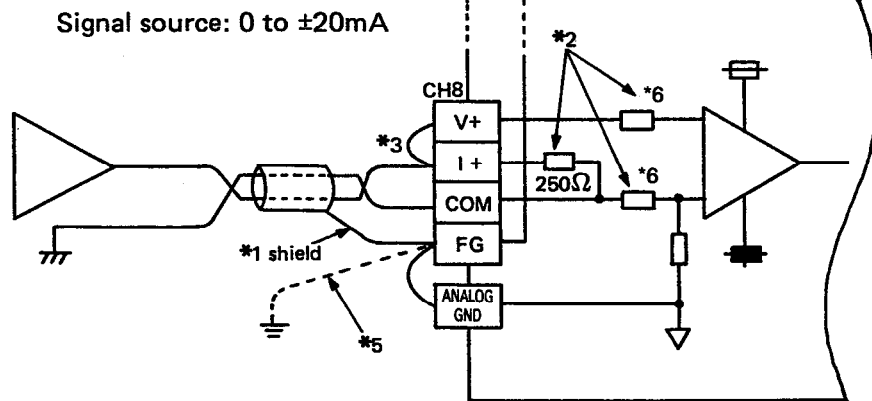

\*1: For the cable, use a two-core twisted shielded wire.

\*2: Indicates the input resistance of the A68AD.

\*3: For current input, be sure to connect the terminals (V+) and (I+).

\*4: If noise or ripple is generated at the external wiring, connect a capacitor of approximately 0.1 to 0.47 $\mu F$  (25V or more voltage resistance parts.) between terminals V and COM.

\*5: If there is excessive noise, ground the unit.

\*6: The internal resistance value will differ according to the hardware version.

Hardware version K and above: 500k $\Omega$

Hardware version J and below: 15k $\Omega$

Confirm the module hardware version with the label attached to the front of the module.

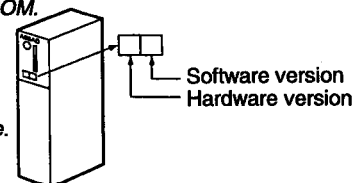

#### POINT

The FG terminal of the A68AD and the FG terminal of the power supply unit are not connected together internally.

## 6. PROGRAMMING

### 6.1 Initial Setting

Before analog to digital conversion begins it is necessary to write certain initial data to the buffer memory. This data consists of the number of channels used and specification of the sampling method required (See section 3.4.1).

The most convenient way to write this data to the buffer memory is to use a single "TO" type instruction as shown in the example below:

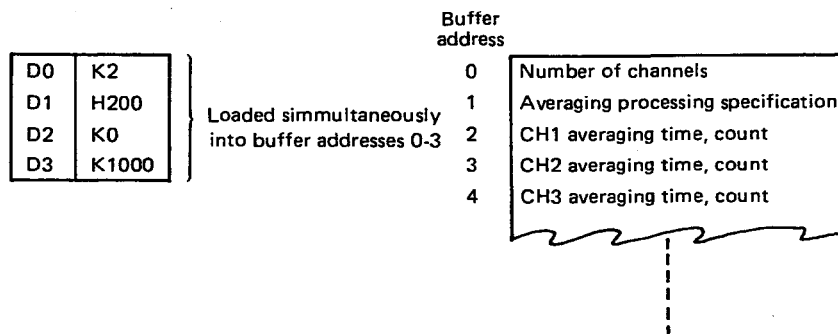
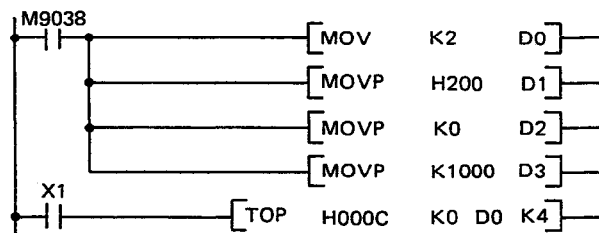

The above example sets the number of channels to 2 (i.e. D0), specifies channel 2 for count averaging (i.e. D1), and sets channel 2 count setting to 1000 (i.e. D3).

The A68AD is located in the main base in the slot with head element number X/Y C0.

The initial data may also be written using individual "TO" type instructions for each buffer address, in this case always execute in the following order:

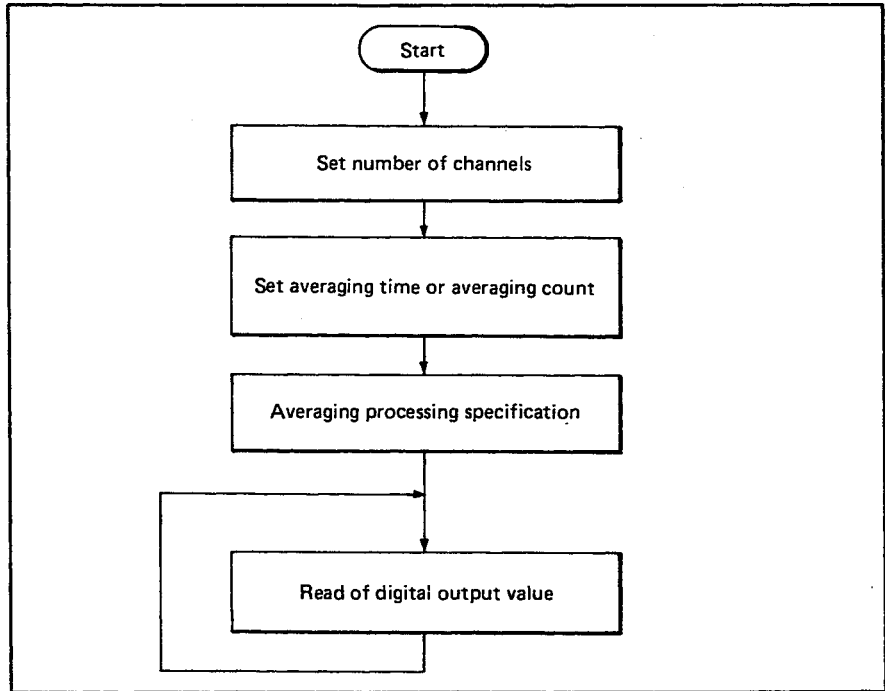
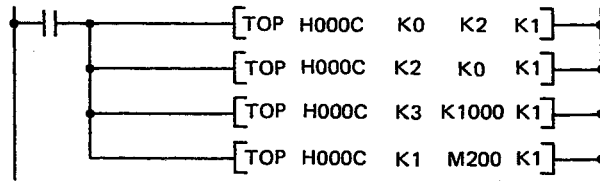

Fig. 6.1 Initial Setting Procedure

When this procedure is used, the previous example must be programmed as follows:



i.e. The count setting (K1000) is loaded into buffer address 3 before averaging processing specification, M200, is loaded into address 1. If this order is changed a write in error may occur. This will cause the run LED on the A68AD to flicker. Error status may also be found by monitoring buffer memory address 34.

This error occurs because the A68AD is normally in run mode. If averaging processing specification is made, the A68AD immediately looks for the relevant averaging data. If this data has not already been written to the unit an error is registered.

6.2 Programming Instructions

This section describes basic programs for read and write operations, setting the number of channels, the specification of averaging processing, read of digital output value and write error code, and application examples.

For further details of instructions, refer to the Programming Manual. When the module, is used in a remote I/O station, refer to the Data link User's Manual.

6.2.1 Basic programs for read and write

(1) Read from A68AD: FROM, FROMP, DFRO, DFROP instructions

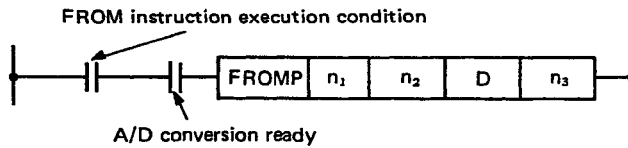

Symbol	Description	Usable Device Number
n <sub>1</sub>	Upper 2 digits of head I/O number assigned to A68AD	K, H
n <sub>2</sub>	Head address of buffer memory which stores data	K, H
D	Head number of device which will stored read data	T, C, D, W, R
n <sub>3</sub>	Number of words of data to be read	K, H

Example: To read the 1 word data from address 10 of the buffer memory to D0, with the A68AD assigned to I/O X130 to 14F and Y130 to 14F

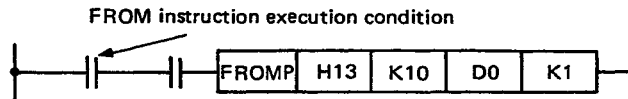

(2) Write to A68AD: TO, TOP, DTO, DTOP instructions

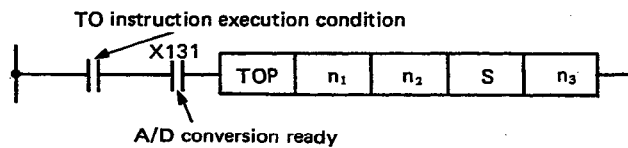

Symbol	Description	Usable Device Number
n <sub>1</sub>	Upper 2 digits of head I/O number assigned to A68AD	K, H
n <sub>2</sub>	Head address of buffer memory which will store data	K, H
D	Head device number or constant where data to be written is stored.	T, C, D, W, R, K, H
n <sub>3</sub>	Number of words of data to be written	K, H

Example: To write 8 to address 0 of the buffer memory, with the A68AD assigned to I/O X60 to 7F and Y60 to 7F

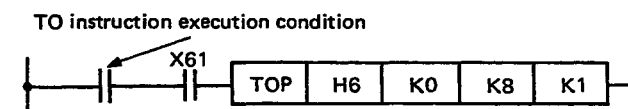



## 6.2.2 Setting the number of channels

- (1) Set the number of channels 1 to 8.
- (2) Even if there is a vacant channel, the number of channels must begin with channel 1. Set the number of the last channel used.
- (3) Program example

To set the number of channels 3

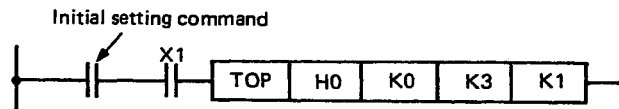

## 6.2.3 Setting of averaging time or averaging count

- (1) Set the averaging time or averaging count to each channel for which averaging processing will be performed.
- (2) Be sure to set the averaging time or averaging count before specifying the averaging processing.
- (3) Set value

Time: 20 to 10000ms (Set the time in units of 10ms.)  
 Count: 1 to 4000 times

- (4) Program example

To set the averaging time of 1000ms to channel 1 and the averaging count of 10 times to channel 3

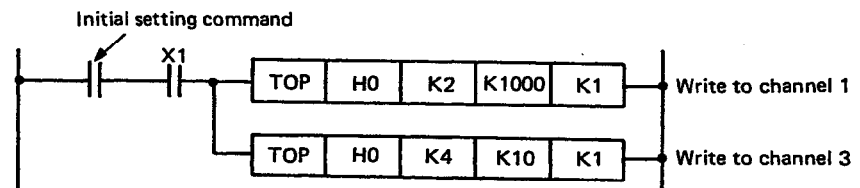

## 6.2.4 Averaging processing specification

- (1) Specify the channels for which averaging processing will be performed, and also specify whether the processing method is count averaging or time averaging.
- (2) Be sure to specify the averaging processing method after setting the averaging time and/or averaging count.

(3) Program example

To specify time averaging processing at channel 1, sampling processing at channel 2, and count averaging processing at channel 3.

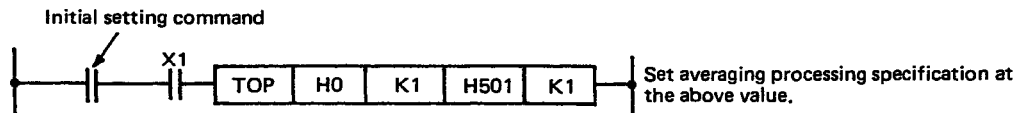
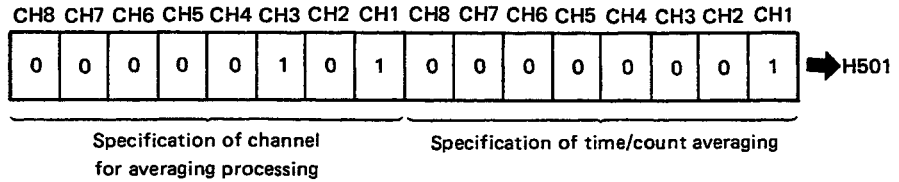

6.2.5 Read of digital output value

- (1) The digital output value is read in 16-bit, signed binary.
- (2) Program example

To read the digital output values of channels 1 to 3 to the D5 to 7.

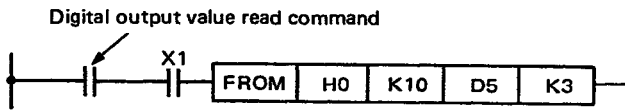

6.2.6 Read and reset of write data error code

- (1) Any error code is set at address 34 of the buffer memory in binary. For details, refer to Section 8.1 (page 8-1).
- (2) Only the first error code to occur, is stored. For details, refer to Section 3.4.2 (page 3-13).
- (3) Reset the error code from the programmable controller CPU.
- (4) Program example

a) To read the error code to D3 and output it to Y100 to 107 in BCD.

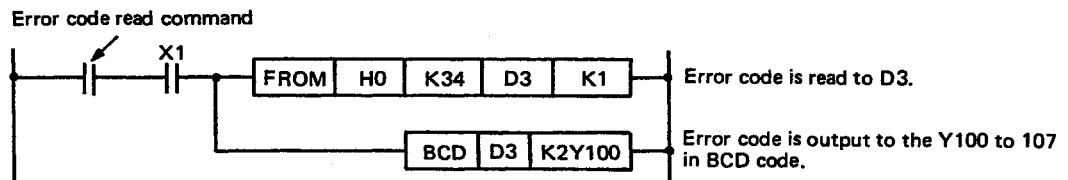

b) To reset the error code

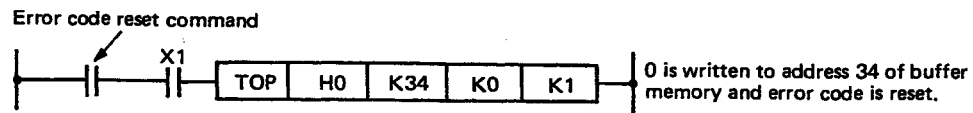

## 6.2.7 Application circuit examples

### (1) Checking the magnitude of the analog signal

Program which turns on Y100 when the digital output value of channel 1 is 700 or more, turns on Y101 when it is between 600 and 700, and turns on Y102 when the value is negative.

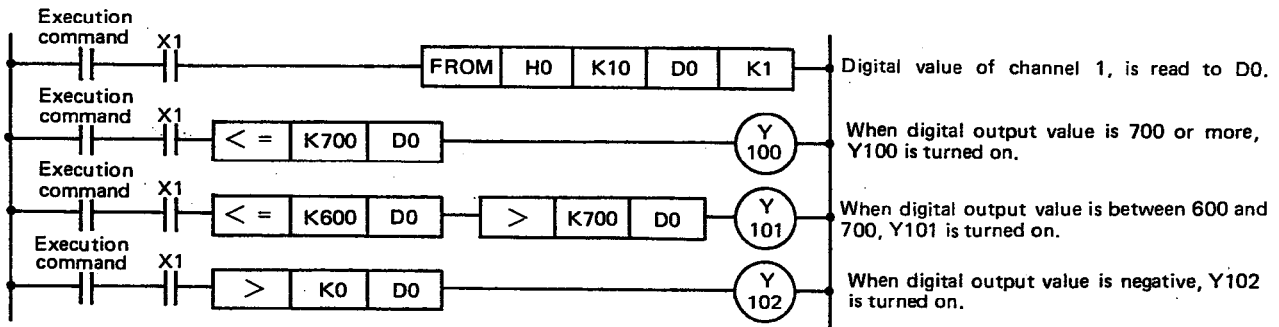

### (2) Digital display of analog signal

Program which outputs the digital output value of channel 1 to Y110 to 11F in BCD and turns on Y120 when that value is negative.

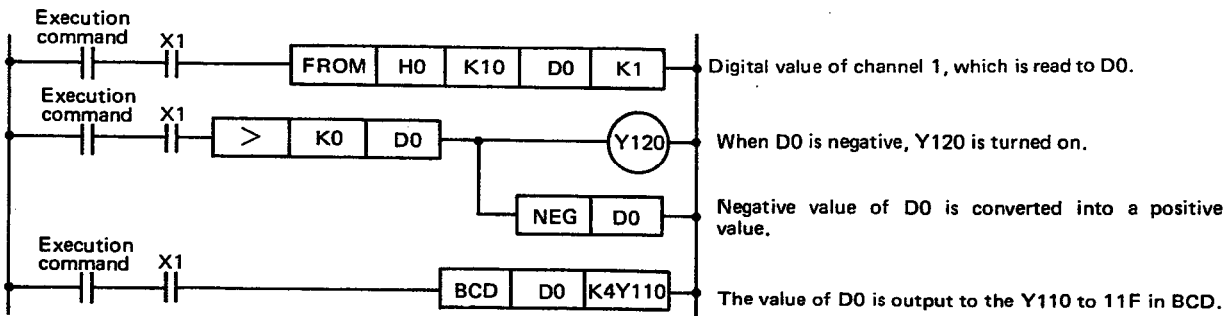

(3) Circuit which changes a gain to 4, 2, 1/2, and 1/4 times by program

The digital output values are changed to the following gains; (all digital value must be > 0)

- Channel 1: 4 times
- Channel 2: 2 times
- Channel 3: 1/2 times
- Channel 4: 1/4 times

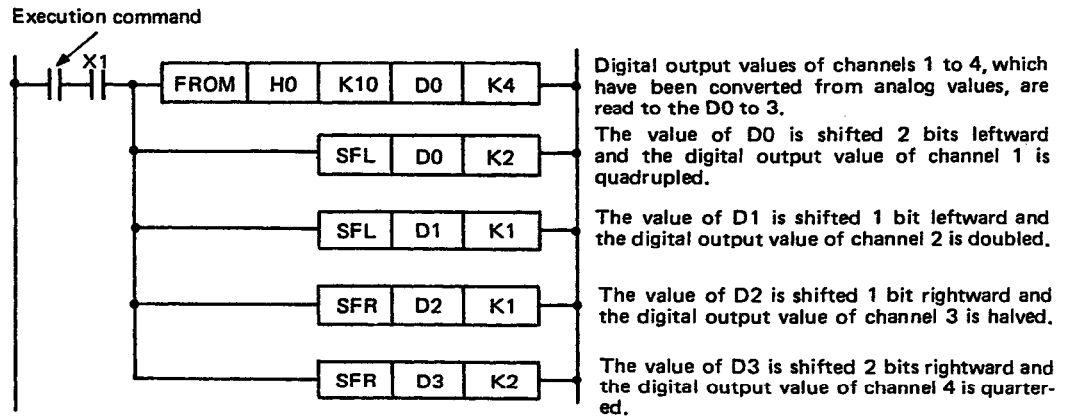

## 7. TEST OPERATION AND CALIBRATION

This chapter describes offset/gain setting.  
See also the A CPU User's Manual.

### 7.1 Offset/Gain Setting

Change the output characteristics as follows. The unit is factory-set to an offset value of 0V and a gain value of 5V.

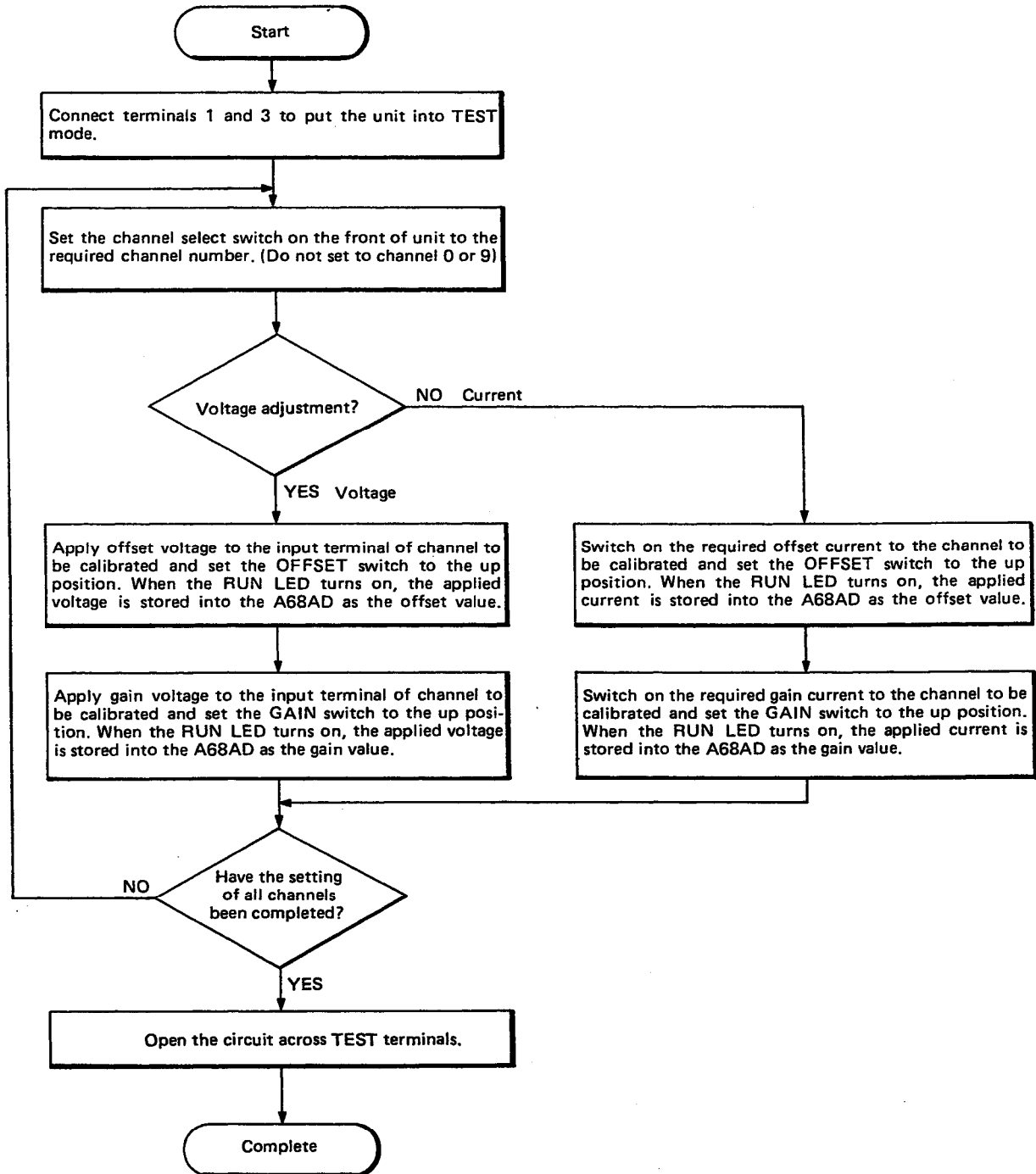

**POINT**

1. The offset value and gain value are stored in the A68AD and are not erased if the power is turned off.
2. Perform the offset/gain setting with the CPU in stop mode. When the unit is set to test mode, A/D conversion is stopped on all channels. Therefore, use the A/D conversion ready signal as an interlock.
3. Perform the offset/gain setting within the range  $-10$  to  $0$  to  $+10V$  DC or  $-20$  to  $0$  to  $+20mA$  DC. If set outside this range, the maximum resolution and overall accuracy may not be within the ranges specified.

## 7.2 Checks before Starting

Number	Checking Point	Description	Check
1	Loading of unit	Is the I/O assignment correct?	
2	Offset/gain setting	Has offset/gain been set for all channels used?	
		Are set values correct?	
		Has the unit been returned to normal mode by opening the circuit across TEST terminals?	
3	Connection to A68AD	Are terminal block connections correct?	
		Are terminal screws of terminal block tightened securely?	
		Is the wire size correct?	

Table 7.1 Points for Checking

## 8. TROUBLESHOOTING

This chapter describes errors, which may occur during the use of the A68AD, and troubleshooting procedures for such errors.

### 8.1 Write Data Error Code List

The following three errors may occur during the write operation of the number of channels, averaging processing specification, averaging time, and averaging count. The numeric value of the error code enclosed in [ ] indicates the channel number for which the error has occurred.

Description	Error Code
A value other than 0 to 8 has been set as the number of channels.	01
A value other than 20 to 10000ms has been set as an averaging time set value.	[ ] 0 to 4
A value other than 1 to 4000 times has been set as an averaging count set value.	[ ] 5 to 8

Table 8.1 Types of Write Data Error Codes

#### POINT

- [ ] 0 to 4 and [ ] 5 to 8 of write data error code are used only to make differentiation between averaging time and averaging count, respectively. The individual numerals do not have any significance.
- When an error has occurred, check the write data error code, reset the error code, and then write the corrected data. (Refer to Section 3.4.2 on page 3-13.)

#### Example:

(1) Error code 32 has occurred

Since the averaging time of channel 3 is wrong, change the value to within the range 20 to 10000ms.

(2) Error code 88 has occurred

Since the averaging count of channel 8 is wrong, change the value to within the range 1 to 4000 times.



## 8.2 Troubleshooting

This section describes simple troubleshooting procedures for use of the A68AD. For problems relating to the CPU module, refer to the A CPU User's Manual.

### 8.2.1 Troubleshooting flow chart

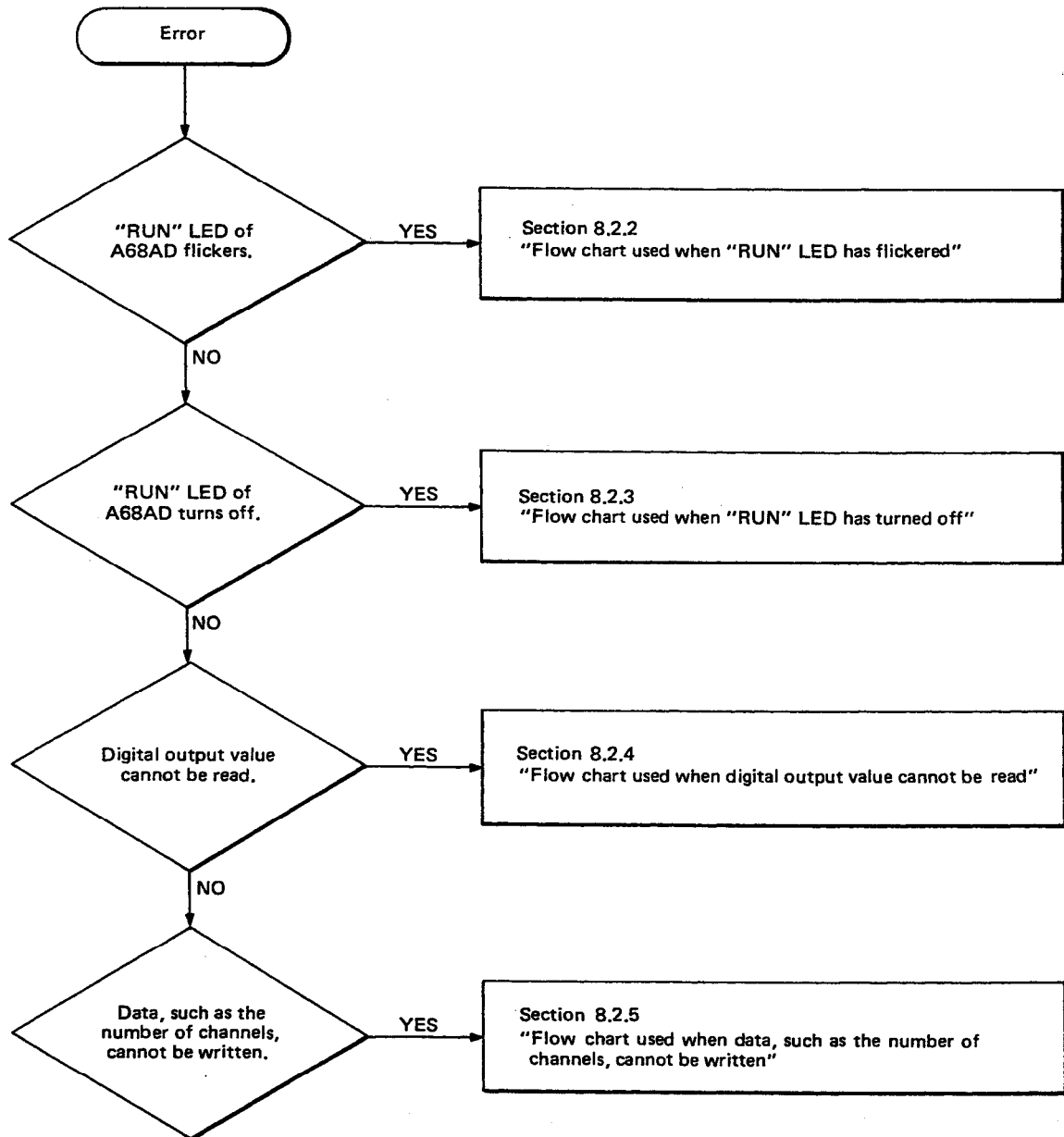

8.2.2 Flow chart used when "RUN" LED has flickered

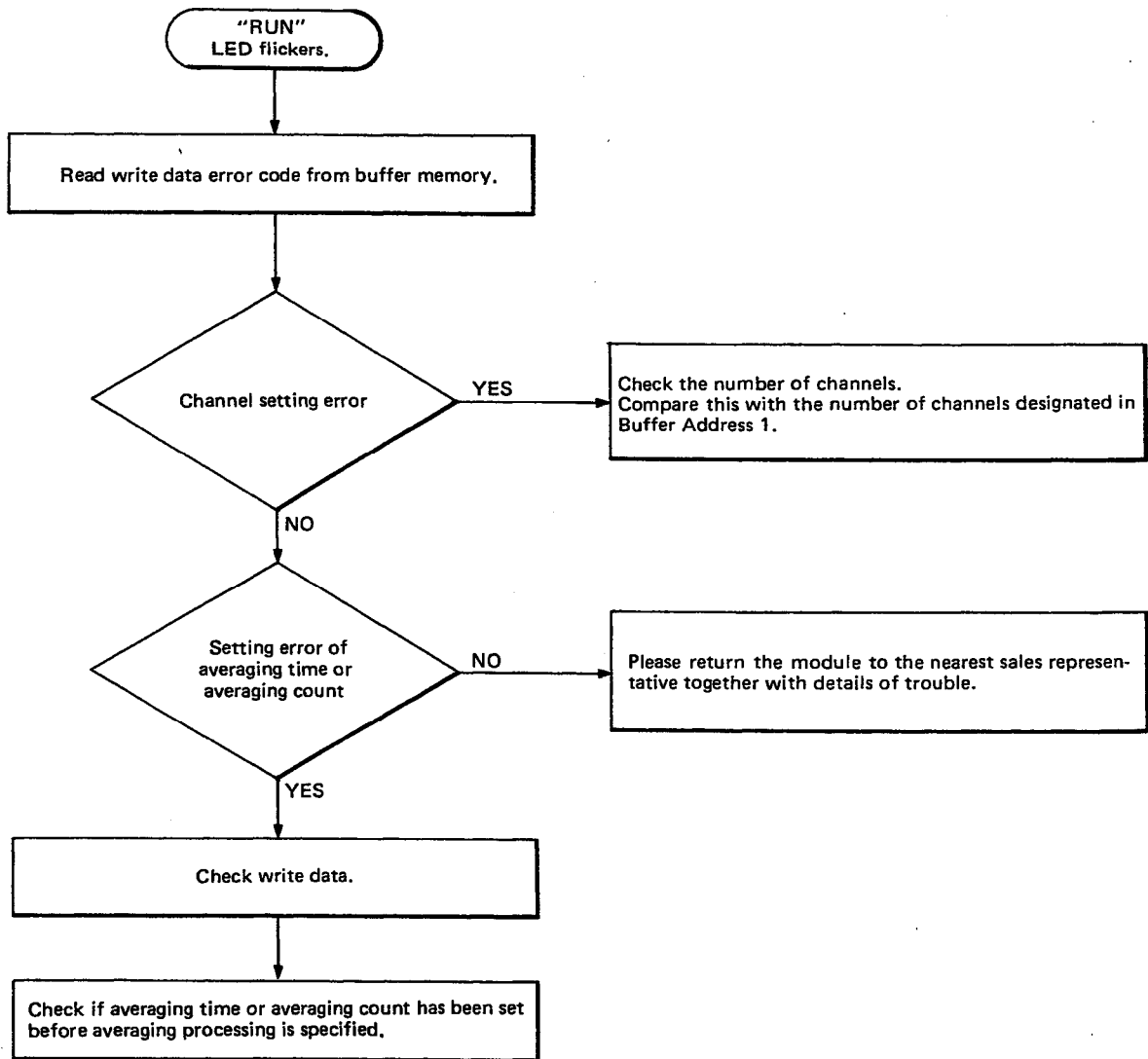

8.2.3 Flow chart used when "RUN" LED has turned off

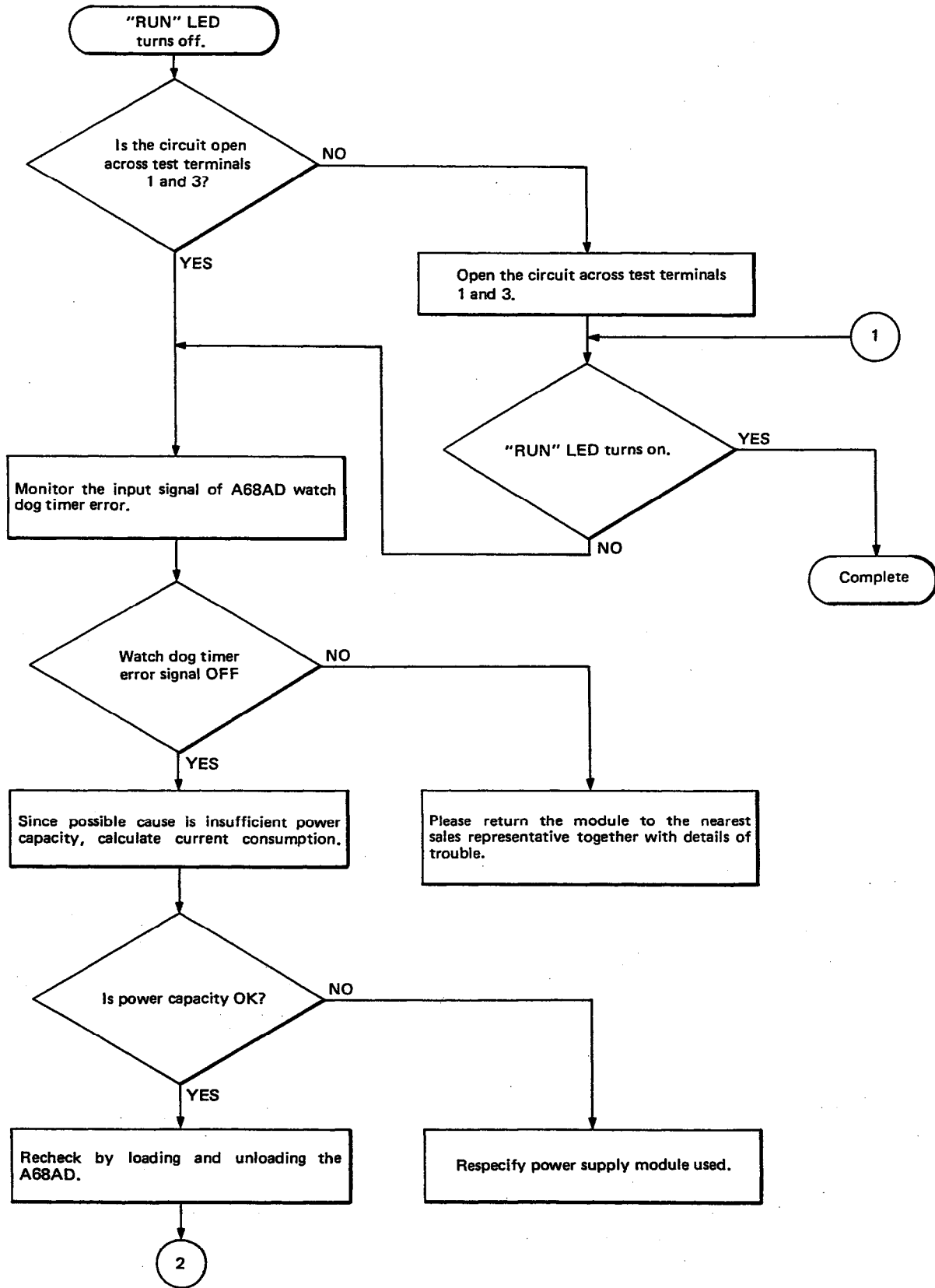

8.2.4 Flow chart used when digital output value cannot be read

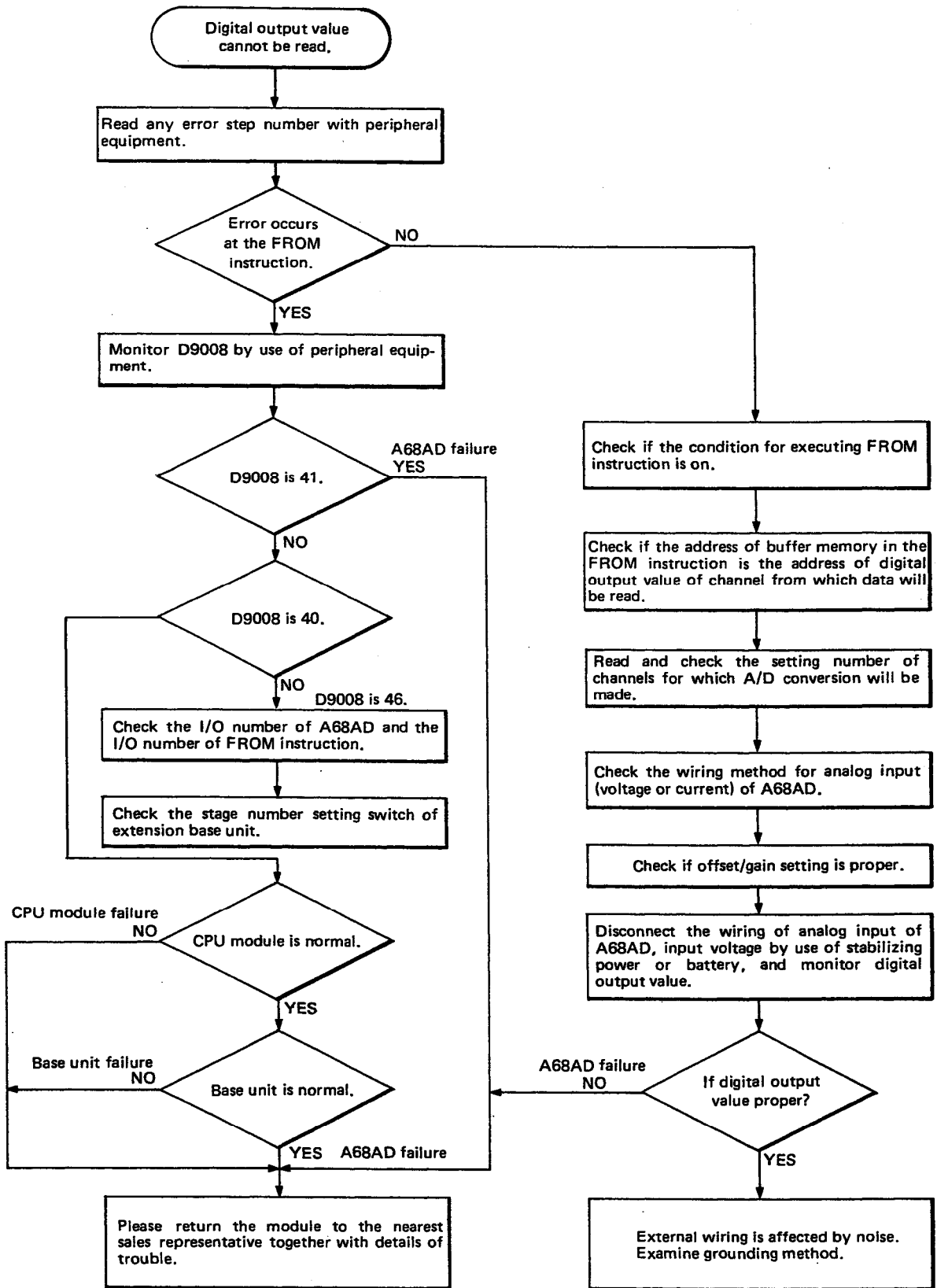

**REMARKS**

The following contents are written into D9008 when an error has occurred during execution of the FROM or TO instruction to the A68AD.

Contents (BIN value) of Special Register D9008	CPU Status	Error and Cause
40	Stop	FROM and TO instructions cannot be executed. Hardware failure of A68AD (special function module), CPU unit, or base unit.
41	Stop	When the FROM or TO instruction has been executed, access has been made to the special function module but no answer is returned. The accessed A68AD (special function module) has failed.
46	Stop ( Continuous operation can be performed by the setting of parameter. )	Access has been made (FROM or TO instruction has been executed) to a slot where the A68AD (special function module) is not loaded. The content of FROM or TO instruction is incorrect or the stage number setting of extension base unit is incorrect.

8.2.5 Flow chart used when data, such as the number of channels, cannot be written

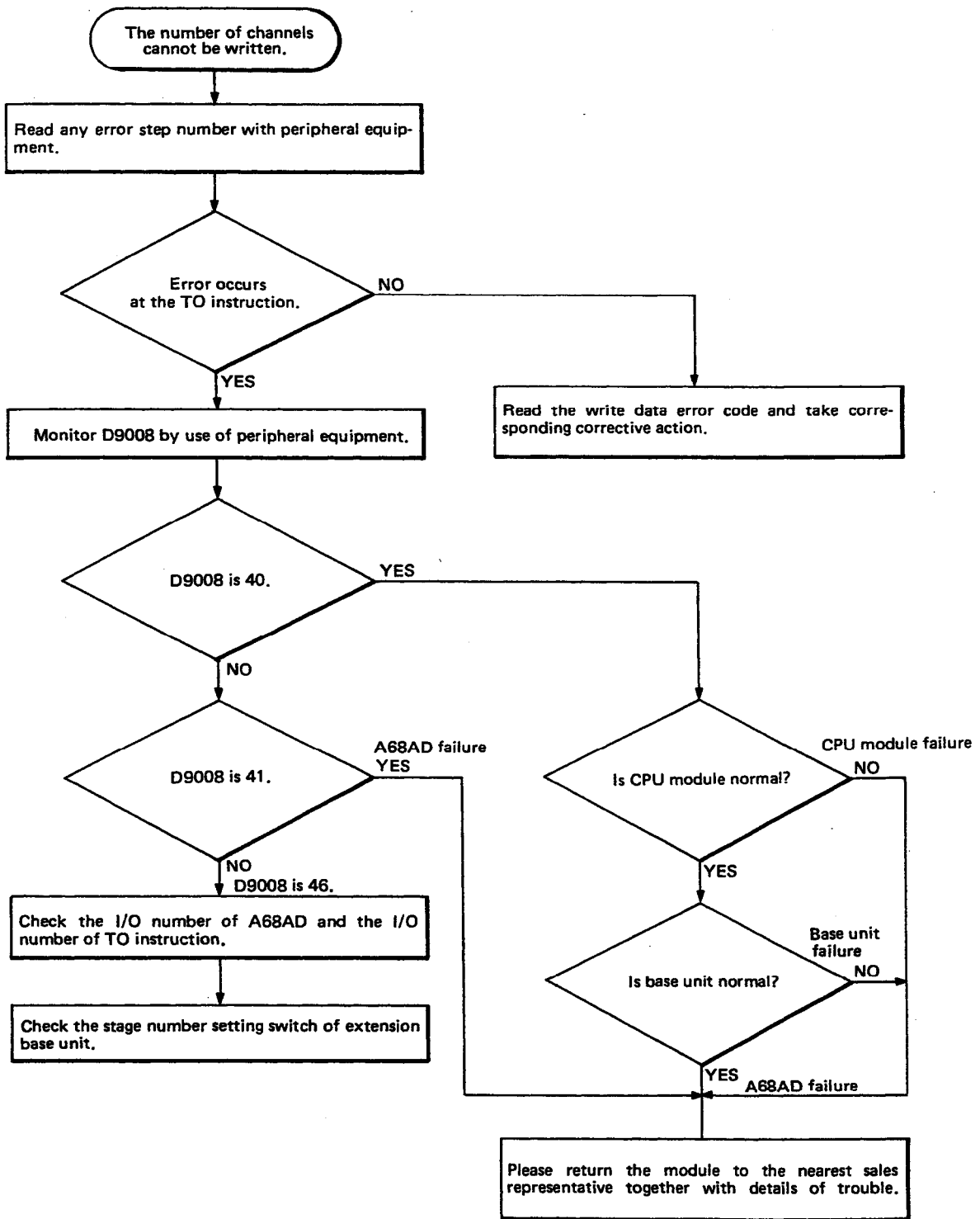

APPENDIX

External View

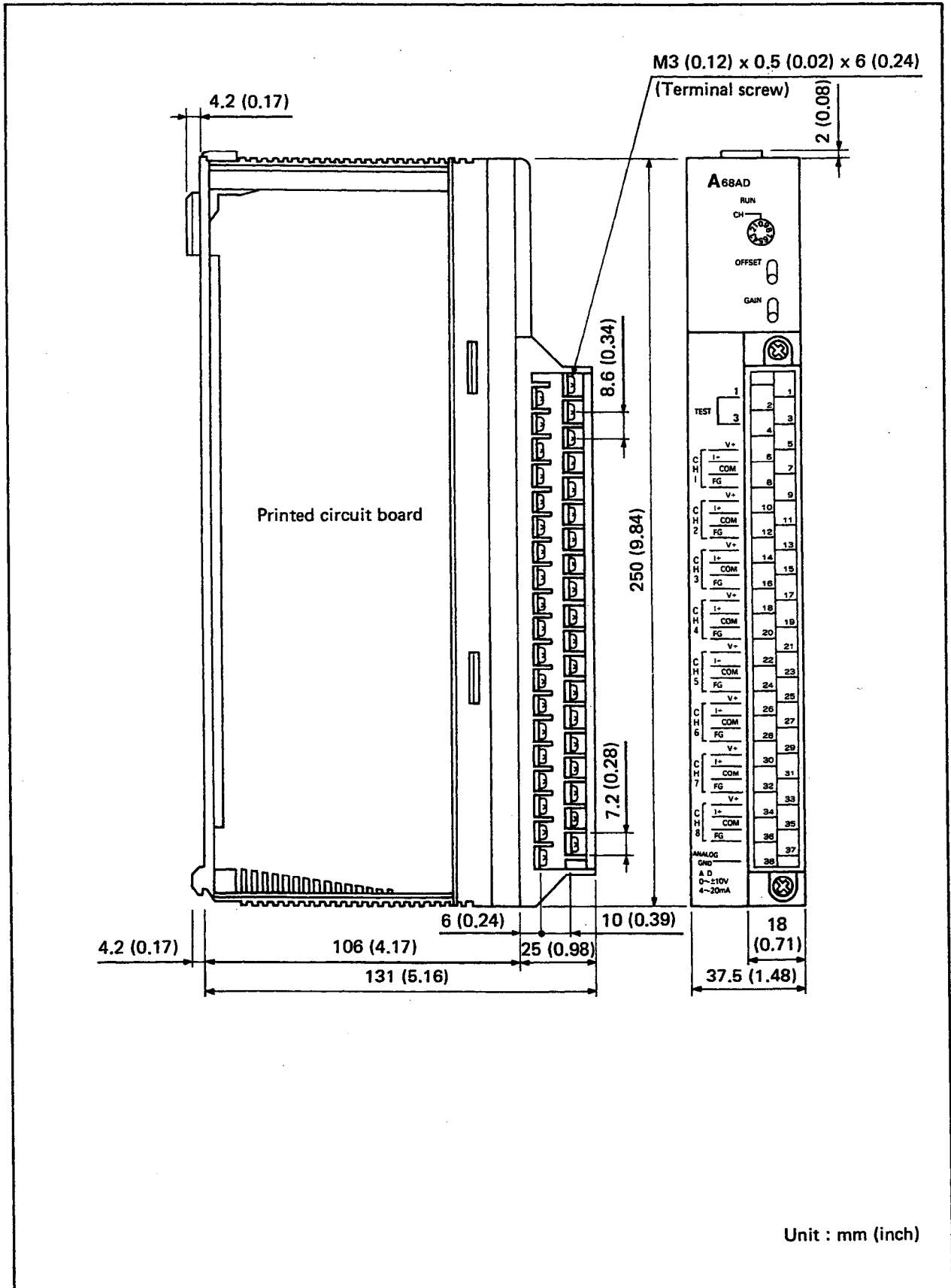

Unit : mm (inch)

# WARRANTY

Please confirm the following product warranty details before starting use.

## 1. Gratis Warranty Term and Gratis Warranty Range

If any faults or defects (hereinafter "failure") found to be the responsibility of Mitsubishi occurs during use of the product within the gratis warranty term, the product shall be repaired at no cost via the dealer or Mitsubishi Service Company. Note that if repairs are required at a site overseas, on a detached island or remote place, expenses to dispatch an engineer shall be charged for.

### [Gratis Warranty Term]

The gratis warranty term of the product shall be for one year after the date of purchase or delivery to a designated place.

Note that after manufacture and shipment from Mitsubishi, the maximum distribution period shall be six (6) months, and the longest gratis warranty term after manufacturing shall be eighteen (18) months. The gratis warranty term of repair parts shall not exceed the gratis warranty term before repairs.

### [Gratis Warranty Range]

- (1) The range shall be limited to normal use within the usage state, usage methods and usage environment, etc., which follow the conditions and precautions, etc., given in the instruction manual, user's manual and caution labels on the product.
- (2) Even within the gratis warranty term, repairs shall be charged for in the following cases.
  1. Failure occurring from inappropriate storage or handling, carelessness or negligence by the user. Failure caused by the user's hardware or software design.
  2. Failure caused by unapproved modifications, etc., to the product by the user.
  3. When the Mitsubishi product is assembled into a user's device, failure that could have been avoided if functions or structures, judged as necessary in the legal safety measures the user's device is subject to or as necessary by industry standards, had been provided.
  4. Failure that could have been avoided if consumable parts (battery, backlight, fuse, etc.) designated in the instruction manual had been correctly serviced or replaced.
  5. Failure caused by external irresistible forces such as fires or abnormal voltages, and failure caused by force majeure such as earthquakes, lightning, wind and water damage.
  6. Failure caused by reasons unpredictable by scientific technology standards at time of shipment from Mitsubishi.
  7. Any other failure found to not be the responsibility of Mitsubishi or the user.

## 2. Onerous repair term after discontinuation of production

- (1) Mitsubishi shall accept onerous product repairs for seven (7) years after production of the product is discontinued. Discontinuation of production shall be notified with Mitsubishi Technical Bulletins, etc.
- (2) Product supply (including repair parts) is not possible after production is discontinued.

## 3. Overseas service

Overseas, repairs shall be accepted by Mitsubishi's local overseas FA Center. Note that the repair conditions at each FA Center may differ.

## 4. Exclusion of chance loss and secondary loss from warranty liability

Regardless of the gratis warranty term, Mitsubishi shall not be liable for compensation to damages caused by any cause found not to be the responsibility of Mitsubishi, chance losses, lost profits incurred to the user by failures in Mitsubishi products, damages and secondary damages caused from special reasons regardless of Mitsubishi's expectations, compensation for accidents, and compensation for damages to products other than Mitsubishi products and other duties.

## 5. Changes in product specifications

The specifications given in the catalogs, manuals or technical documents are subject to change without prior notice.

## 6. Product application

- (1) In using the Mitsubishi MELSEC programmable logic controller, the usage conditions shall be that the application will not lead to a major accident even if any problem or fault should occur in the programmable logic controller device, and that backup and fail-safe functions are systematically provided outside of the device for any problem or fault.
- (2) The Mitsubishi general-purpose programmable logic controller has been designed and manufactured for applications in general industries, etc. Thus, applications in which the public could be affected such as in nuclear power plants and other power plants operated by respective power companies, and applications in which a special quality assurance system is required, such as for each Japan Railways company or the Department of Defense shall be excluded from the programmable logic controller applications.

Note that even with these applications, if the user approves that the application is to be limited and a special quality is not required, application shall be possible.

When considering use in aircraft, medical applications, railways, incineration and fuel devices, manned transport devices, equipment for recreation and amusement, and safety devices, in which human life or assets could be greatly affected and for which a particularly high reliability is required in terms of safety and control system, please consult with Mitsubishi and discuss the required specifications.



# A/D converter module type A68AD

## User's Manual

MODEL	A68AD-USERS-E
MODEL CODE	13J607
IB(NA)-66054-E(0307)MEE	



HEAD OFFICE : 1-8-12, OFFICE TOWER Z 14F HARUMI CHUO-KU 104-6212, JAPAN  
NAGOYA WORKS : 1-14, YADA-MINAMI 5-CHOME, HIGASHI-KU, NAGOYA, JAPAN

When exported from Japan, this manual does not require application to the Ministry of Economy, Trade and Industry for service transaction permission.

Specifications subject to change without notice.